

# GS 900 Ceiling Mount Assembly Instructions



# GS 900 Ceiling Mount Assembly Instructions

- Dear User,  
The ceiling mount should only be installed by a technical expert (electrical engineer, technician) or a comparably qualified person.

# GS 900 Ceiling Mount Assembly Instructions

- Ships in 3 boxes:



# GS 900 Ceiling Mount Assembly Instructions

- Box 1: Ceiling Mount Swing/Extension Arms



# GS 900 Ceiling Mount Assembly Instructions

- Box 1 Contents



Operating Manual

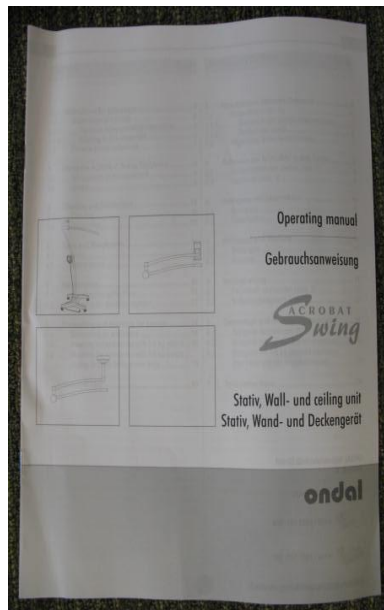

Installation Instructions

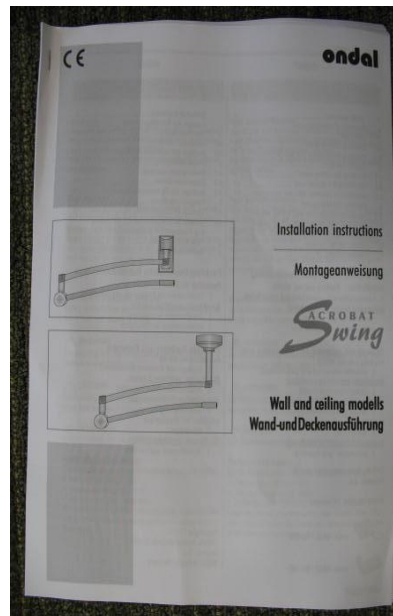

Hardware Kit

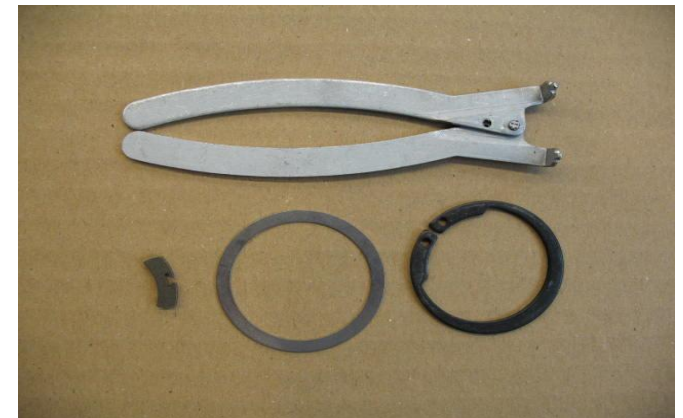

# GS 900 Ceiling Mount Assembly Instructions

- Box 2: Spacer Tube Box



# GS 900 Ceiling Mount Assembly Instructions

- Contents of Box 2:

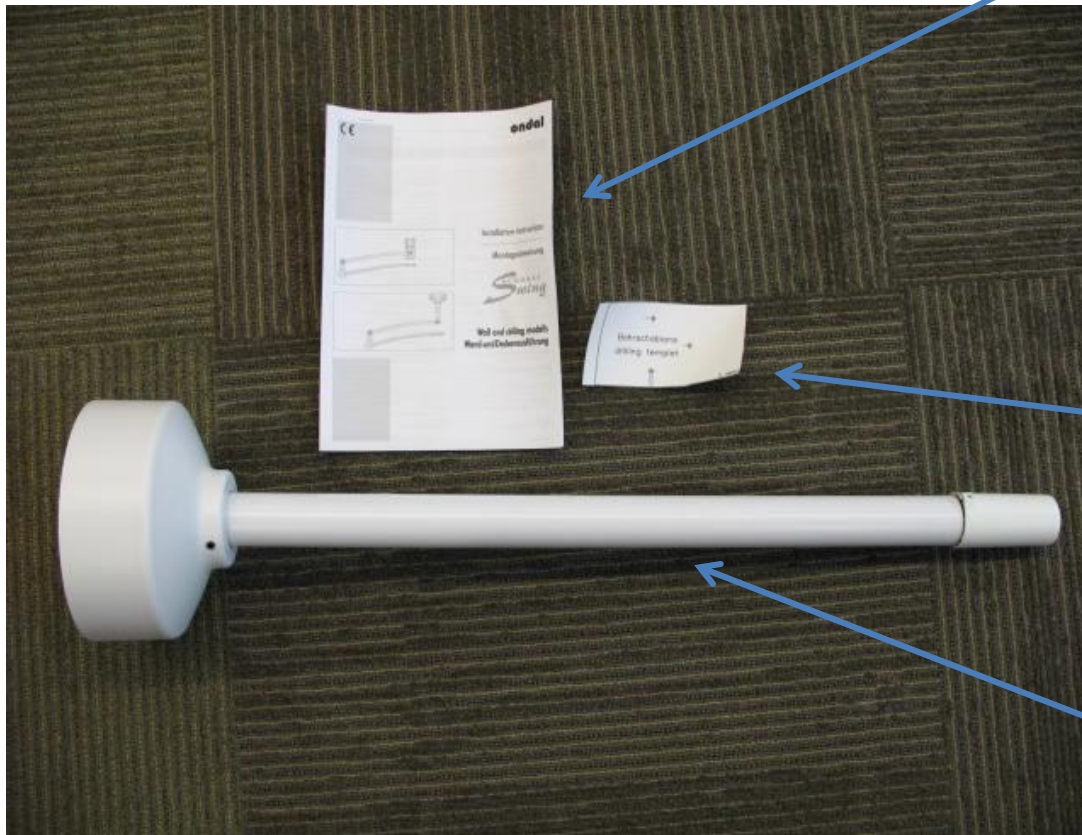

Installation Instructions

Drilling Template



Spacer Tube

# GS 900 Ceiling Mount Assembly Instructions

- **Please note** parts located in the plastic sleeve of the spacer tube as indicated below



View from top

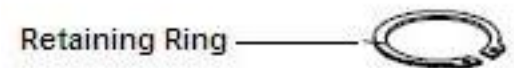
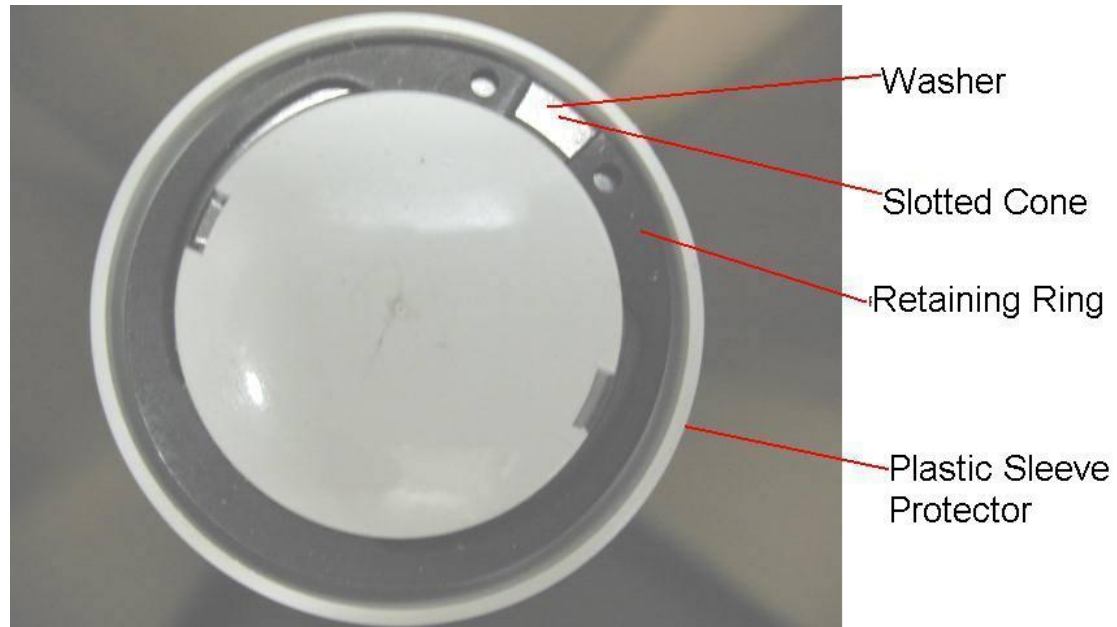



# GS 900 Ceiling Mount Assembly Instructions

- Box 3



Luminaire



# GS 900 Ceiling Mount Assembly Instructions

## Mounting Spacer Tube

Note: Spacer Tube is designed to accommodate ceilings between 8-10ft.

Tubing is shipped to accommodate a 10 ft ceiling and can be shortened to accommodate an 8ft. ceiling. **If at all possible**, secure mounting plate 10 ft off the floor (even if this requires mounting the plate above a false ceiling).

If shortening is required follow instructions on next 4 pages.

# GS 900 Ceiling Mount Assembly Instructions

## Shortening Spacer Tube

- Remove wires from terminal block on the mounting plate



Remove pin/steel bearing sleeve and wires running inside spacer tube



# GS 900 Ceiling Mount Assembly Instructions

- Trim spacer tube to accommodate actual ceiling height.
- Drill and tap 3 holes (5mm diameter and M6 thread)
  - Use drill template provided with Ondal Installation Instructions (or dimensions on next page)

Place drill template at the edge of the tube





# GS 900 Ceiling Mount Assembly Instructions

- Reinstall wire through tubing and into terminal block

Ground wire to mounting plate

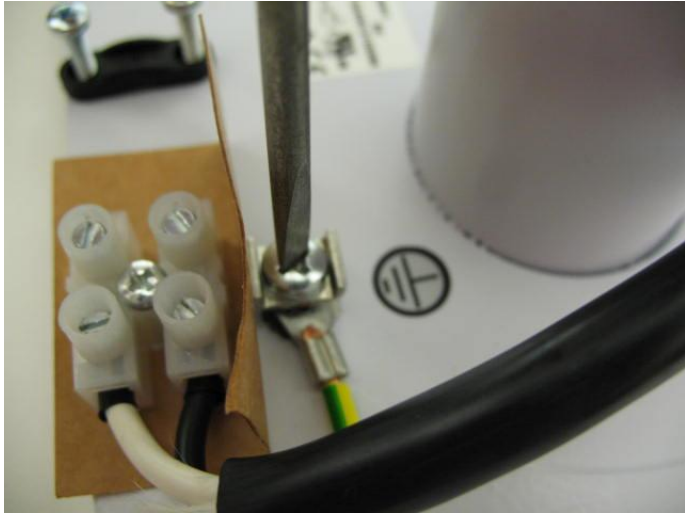

Insert other two set screws and tighten



Insert set screw with additional length ensuring screw engages the hole in the pin/steel bearing sleeve

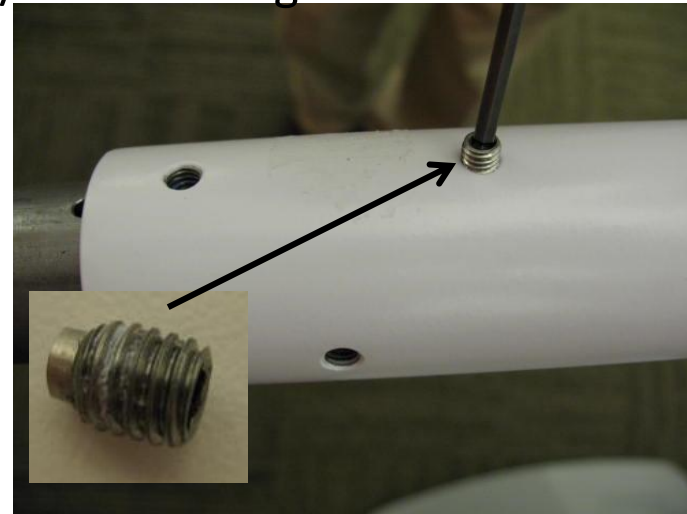

# GS 900 Ceiling Mount Assembly Instructions

## Mounting Spacer Tube

- Loosen three threaded pins/set screws(1) and remove fixture flange/bezel(2)
- Using the drilling template (or with dimensions on next page) fasten spacer tube mounting plate to the ceiling
- The indicated transformer is not part of the GS900 system and is not supplied with the assembly (see wiring instructions on page 17)

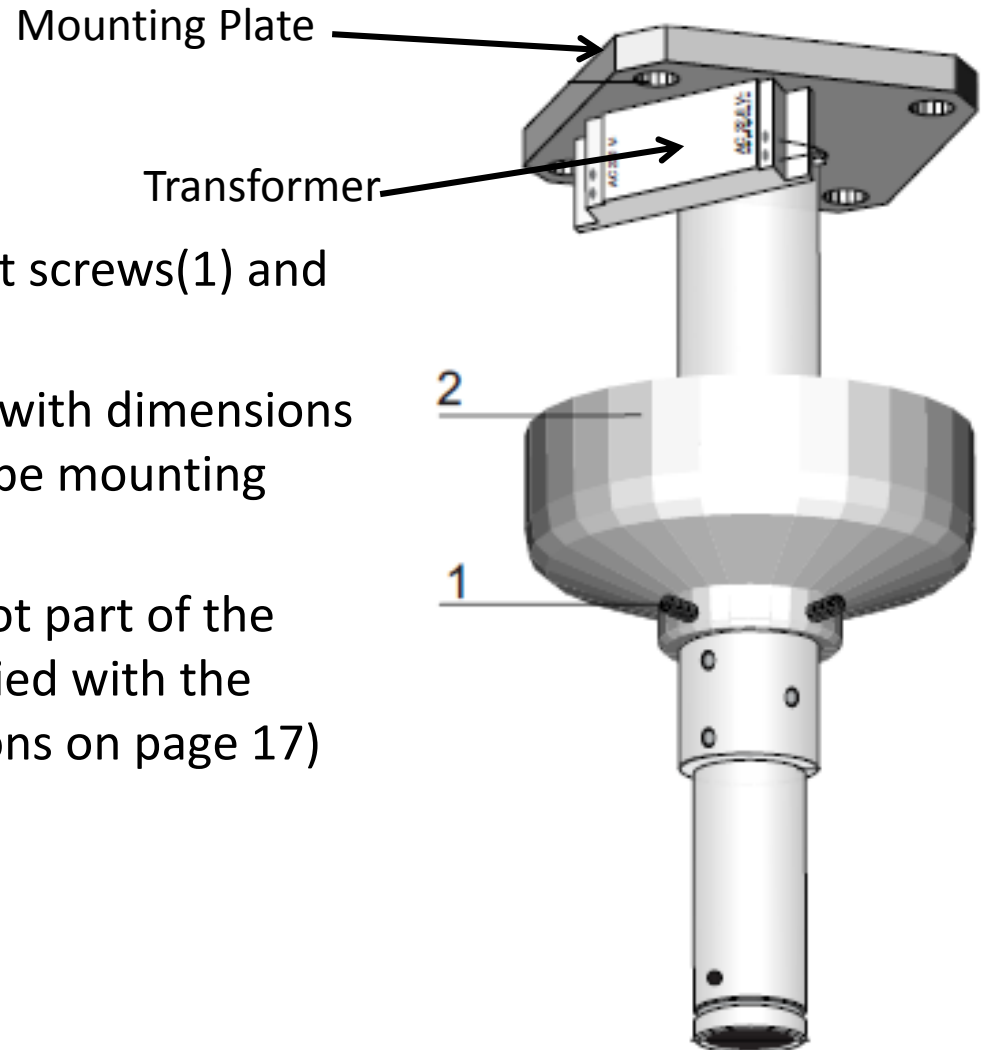

# GS 900 Ceiling Mount Assembly Instructions

- Drilling Template Dimensions

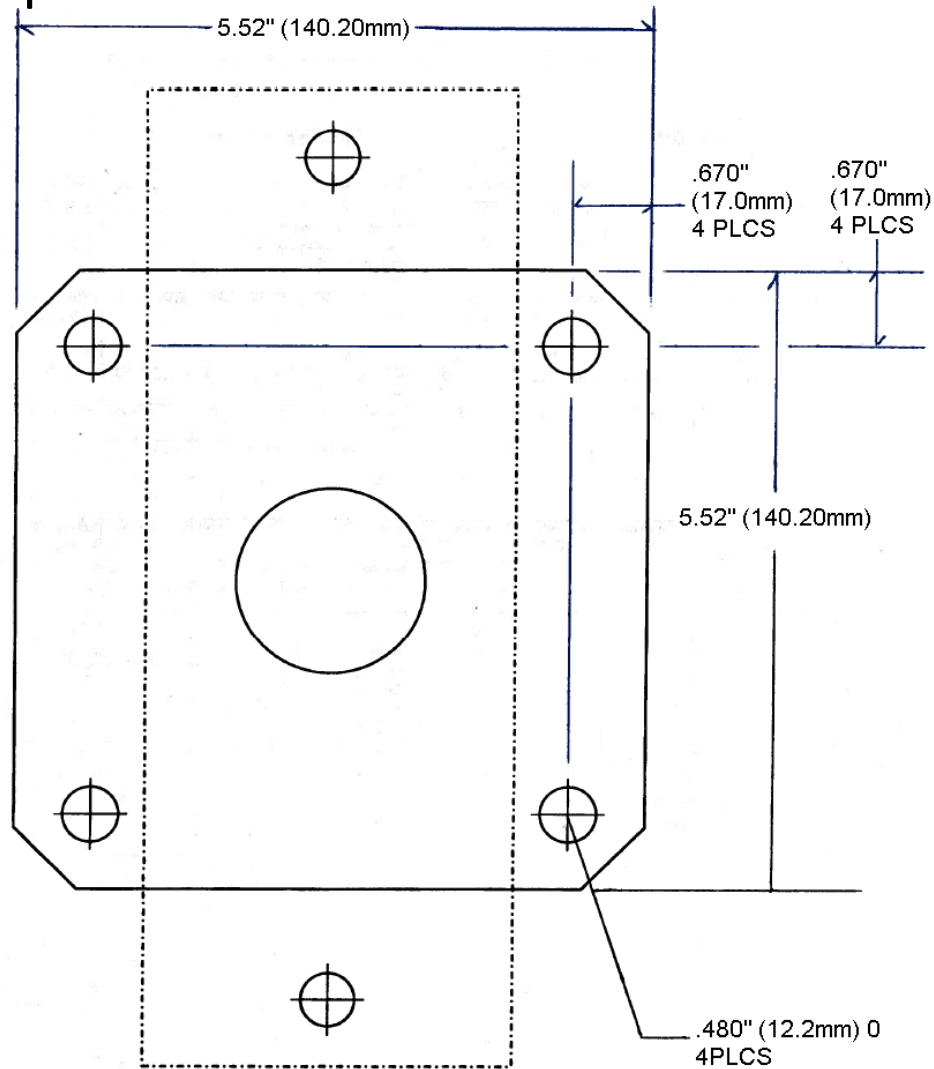



# GS 900 Ceiling Mount Assembly Instructions

## Wiring Instructions

- Connecting power wires



Domestic (see above image)

Black -- Hot

White -- Neutral

Green – Green/yellow -- Ground

International

Brown -- Hot

Orange -- Neutral

Green – Yellow -- Ground

# GS 900 Ceiling Mount Assembly Instructions

## Connecting Spring Arm to Extension Arm



Remove and discard protective cover

# GS 900 Ceiling Mount Assembly Instructions

Remove plastic cap/electrical connector from one end of the extension arm

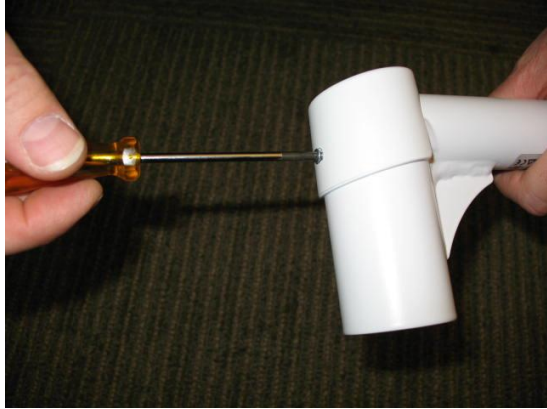

# GS 900 Ceiling Mount Assembly Instructions

Slide spring arm bearing into extension arm



Place washer



Install Spring Clip using tool



Replace plastic cap/electrical connector and secure with screw



# GS 900 Ceiling Mount Assembly Instructions

## Mounting Extension Arm to Spacer Tube

Remove plastic cap/electrical connector from other end of extension arm

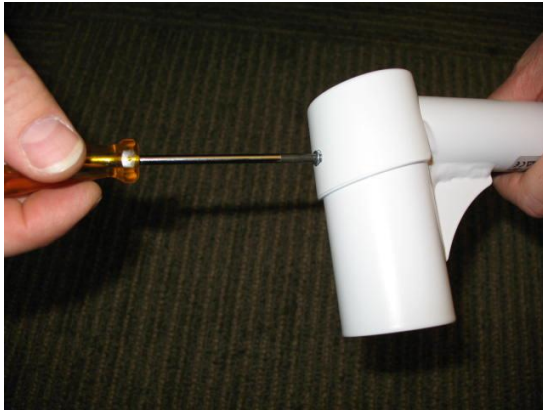

Slide Extension  
Arm onto Spacer  
Tube Bearing



# GS 900 Ceiling Mount Assembly Instructions

Place washer



Place slotted cone inserting  
cone feature into hole in  
bearing



Install spring clip using tool



**Please note:** these parts are  
located in the spacer tube bearing  
protective sleeve

# GS 900 Ceiling Mount Assembly Instructions

Replace plastic cap/electrical connector and secure with screw



**Please note:** The spring tension of the spring arm is preset by the manufacturer (Ondal). The luminaire must be attached for the spring arm to balance.

# GS 900 Ceiling Mount Assembly Instructions

## Attaching Luminaire to Spring Arm



Remove and discard protective cover





# GS 900 Ceiling Mount Assembly Instructions

Loosen the slotted screw



Rotate plastic collar 180° to reveal key slot

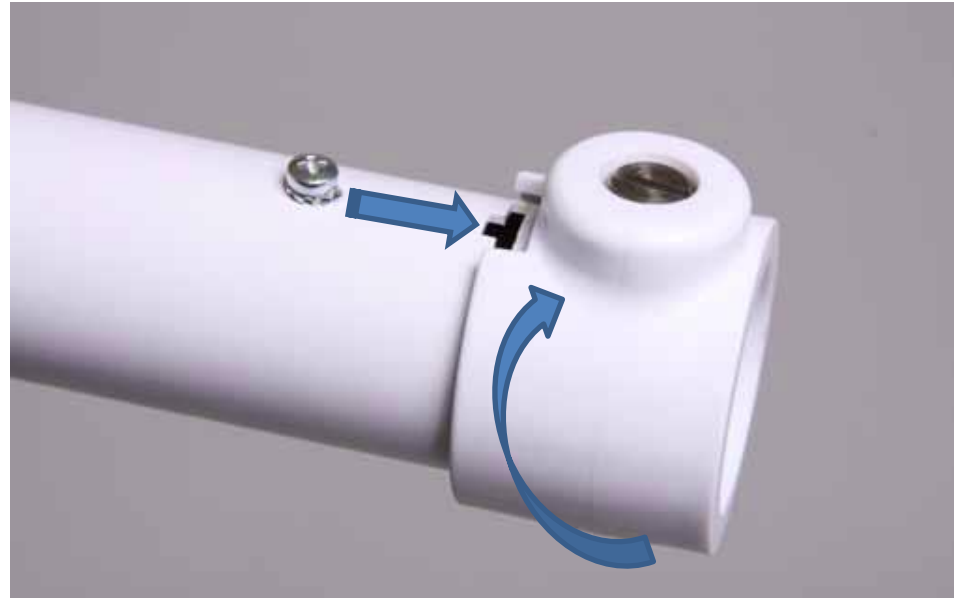

Loosen (do not remove) the Phillips head screw

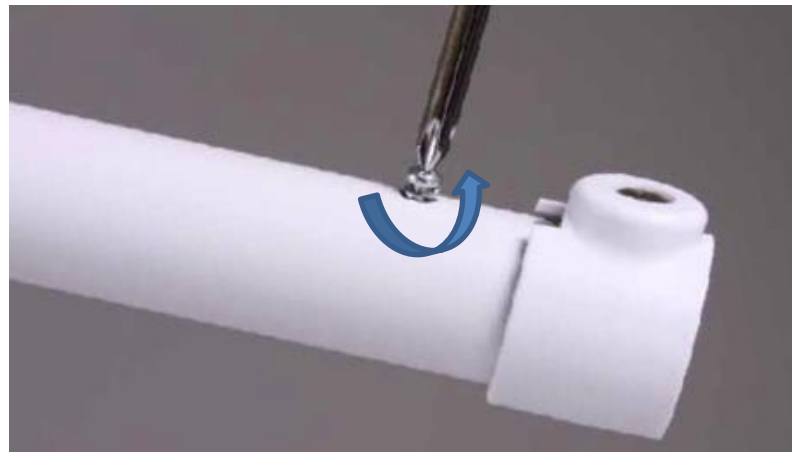

# GS 900 Ceiling Mount Assembly Instructions

- Insert luminaire into the spring arm



# GS 900 Ceiling Mount Assembly Instructions



Place securing segment completely into slot



# GS 900 Ceiling Mount Assembly Instructions

- Tighten Phillips head screw, turn plastic sleeve 180° and tighten slotted screw



# GS 900 Ceiling Mount Assembly Instructions

- Turn on light to ensure it is working properly

