

LikoGuard™

Overhead Lift

Instructions for Use

LikoGuard™ L Prod. No. 3301030

LikoGuard™ XL Prod. No. 3301040

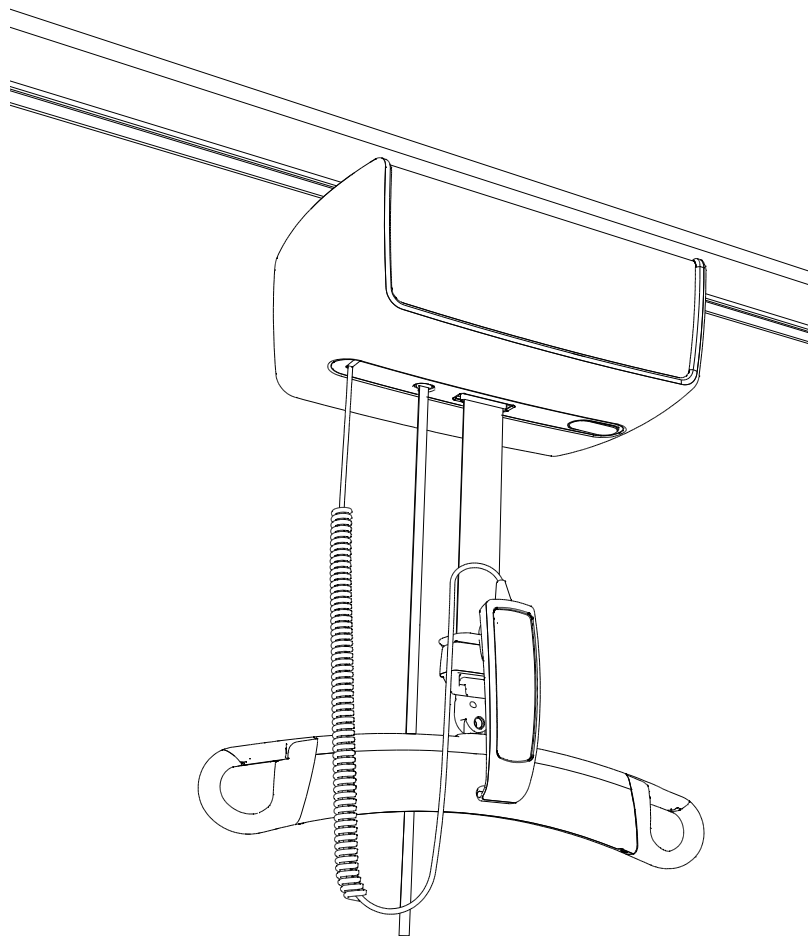

Table of Contents

1. Introduction	3
1.1 Symbol description	4
1.2 Product description	5
1.3 Definitions	6
2. Safety information	7
2.1 Intended use.....	7
2.2 Maximum load.....	8
3. Instructions for use	9
3.1 Check before every lift.....	9
3.2 Move the lift correctly	9
3.3 Leave the lift in the correct position after use.....	9
3.4 Choosing the correct Sling.....	10
3.5 Plan the transfer	11
3.6 Apply the sling to the patient	13
3.7 Connect the sling to the sling bar	13
3.8 Before lifting the patient from the surface	13
4. Functions and controls	14
4.1 Hand control	14
4.2 Hand control with display.....	15
4.3 Menus and information	16
4.4 Charging the lift battery.....	18
4.5 Alternative charging system	18
4.6 Limit Switch	18
4.7 Operation panel on lift	18
4.8 Emergency stop	19
4.9 Emergency lowering devices	19
4.10 Quick attachment device	19
4.11 Latches on sling bar	20
5. Recommended lifting accessories	20
6. Trouble shooting	22
7. Inspection and maintenance	23
7.1 Care and maintenance.....	23
7.2 Service	23
7.3 Service agreement.....	23
7.4 Expected life time	23
7.5 Transport and storage.....	23
7.6 Product changes	23
7.7 Notice to Users and/or Patients in EU	23
7.8 Recycling Instructions	24
8. Product data	25
8.1 Technical specifications	25
8.2 Dimensions	25
8.3 Electromagnetic emissions	26
8.4 Electromagnetic immunity	26
9. Cleaning and disinfection	30
9.1 Equipment	30
9.2 Cleaning instructions	30
9.3 Disinfection instructions.....	30
9.4 Use of cleaning and disinfecting agents on the LikoGuard™ Overhead lift	31

1 Introduction

Thank you for choosing a Liko™ product. With a genuine regard for safety and ease of use, patient handling solutions from Liko have for decades been greatly appreciated by healthcare facilities worldwide. The LikoGuard™ overhead lift series is a new generation platform built with experience combined with innovation to meet the future of overhead lift systems. With powerful performance and enhanced safety design, the LikoGuard Overhead lift is the latest addition to the long line of Liko™ quality products, designed and manufactured in Sweden.

Hill-Rom offers training in patient handling techniques in order to ensure that the equipment is used in a safe and effective way. For training on the use of this product, contact your local Hill-Rom representative.

Manufacturer:



Liko AB

Nedre vägen 100





















975 92 Luleå





+ 46 - 920 - 474700

+ 46 - 920 - 474701

1.1 Symbol description

These symbols can be found in this document and/or on the product.

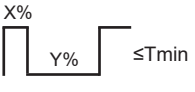
Symbol	Description
	Warning; this situation requires extra care and attention.
	Overload, the lifts maximum load or its duty cycle are exceeded.
	Caution; Failure to follow the instructions may lead to damage to the product.
	Service required
	Sound signal (audible)
	Read the instructions for use for detailed information.
	Intended for indoor use.
	The product has extra protection against electric shock (Insulation Class II).
	Protection level against electric shock Type B.
	Risk ongoing, read instructions for use before use.
	This product complies with EC directives.
IP N ₁ N ₂	Protection level against dust (N ₁) and protection level against moisture (N ₂).
	Manufacturer
	Date of manufacture.
	All batteries in this product must be recycled separately.
	The material is recyclable.
	Emergency stop
	Emergency lowering
	Product Identifier
	Serial Number
	Medical Device

	The safety and essential performance of medical electrical equipment
	Proof of Product compliance to North American safety standards
	Non-ionizing electromagnetic radiation
	Duty cycle for non-continuous operation. The maximum active operation time X% of any given time unit, followed by a deactivation time, Y%. The active operation time shall not exceed the specified time in minutes, T.
	GS1 Data Matrix Barcode that may contain following information (01) Global Trade Item Number (11) Production Date (21) Serial Number



Read and understand the instructions for use in its entirety before using the product.
Use of the product without a full understanding of the contents is subject to risk.

Always keep the instructions for use close at hand for daily user access.

1.2 Product description

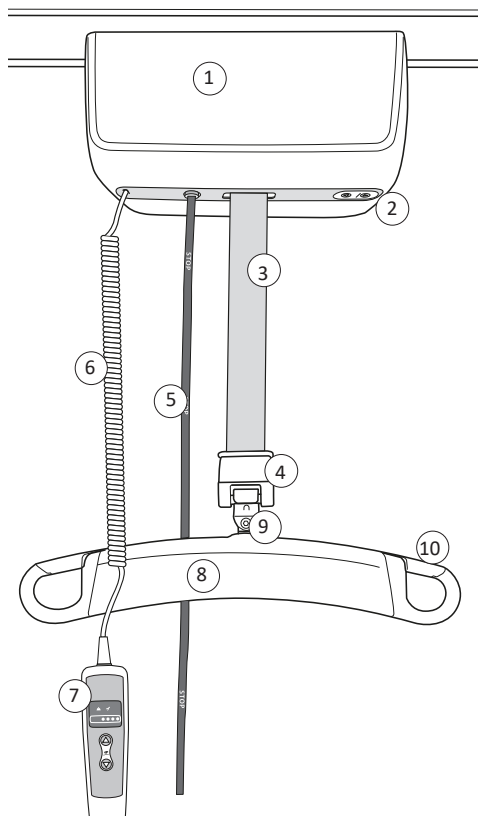

1. Lift motor.
2. Operation panel on lift
- Electronic raising / lowering of lift strap.
3. Lift strap.
4. Multi-link; attachment point at lift strap.
5. Emergency stop
- Mechanical Emergency lowering device.
6. Cable for hand control.
7. Hand control.
8. Sling bar.
9. Attachment point at sling bar.
10. Latches.

1.3 Definitions

Lifting area

The lifting area, marked in grey, is the area under the actual overhead system where safe lifting may be carried out.

A overhead system can be constructed as a Straight-rail or a Traverse System.

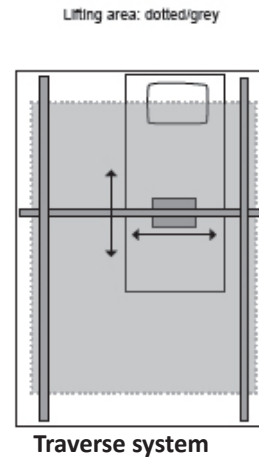
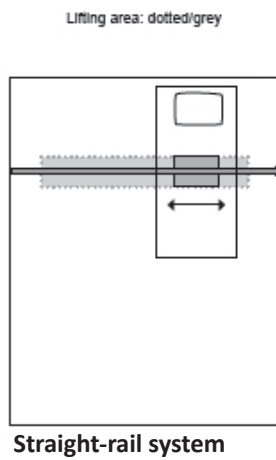

 Never lift a patient to or from a location outside of the lift systems lifting area!

Lifting point

The lifting point is the lift's position in the overhead system for transfers between different objectives.

See examples of lift points below:

1. bed
2. wheelchair
3. water closet (toilet).

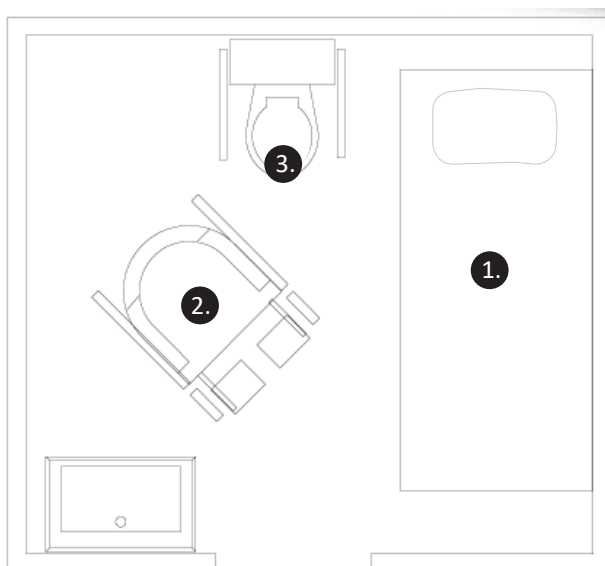

 Remember to always plan the lifting operation to and from the lifting points!

2. Safety information

2.1 Intended Use

The LikoGuard™ Overhead lift is part of a Liko™ overhead lift system and is intended for use in following environments: Health care, Intensive care, Emergency ward, Rehabilitation, Habilitation and Home healthcare environment. An overhead lift system can be used for:

- Lifting between a bed and a wheelchair and for toileting.
- Lifting to / from the floor.
- Lifting together with a stretcher.
- Rehabilitation training such as walking and standing.

The intended use for the LikoGuard overhead lift does not include any lifting by the patient / person alone. Lifting and transferring a person shall always be performed with the assistance of at least one caregiver for the patient.

The LikoGuard overhead lift is used as a means to perform the lift but is not in contact with the patient; therefore we do not go into the various patient conditions in this manual.

Essential performance: The product shall not move unintentionally while being submitted to disturbances.

Contact your Hill-Rom representative for support and advice.

Expected Life Time		Load Case 1	Load Case 2	Load Case 3	Load Case 4
		363 kg (800 lbs.)	272 kg (600 lbs.)	200 kg (440 lbs.)	100 kg (220 lbs.)
Total normal lifts*		14500	19000	26000	52000
5 years	lifting frequency	8 lifts/day	10 lifts/day	14 lifts/day	29 lifts/day
	7 years	5 lifts/day	7 lifts/day	10 lifts/day	20 lifts/day
	10 years	4 lifts/day	5 lifts/day	7 lifts/day	14 lifts/day

*A normal lift = 70 cm up of which 40 cm with load followed by 70 cm down of which 40 cm with load.

*A normal lift = 27.6 inch. up of which 15.7 inch. with load followed by 27.6 inch. down of which 15.7 inch. with load.



The lift must not be used beyond its expected life time.



The lift must be installed by Hill-Rom trained personnel, in accordance with Liko's current installation instructions and recommendations regarding the lift system in question. The lift shall only be installed into Liko rails intended for Liko overhead systems.



The lift must not be modified under any circumstances. If you have any questions, please contact Hill-Rom.

The lift may not be used in areas where flammable goods are stored or where flammable mixtures may occur.

Use of the product adjacent to other equipment should be avoided because it could result in improper operation, if such use is necessary, observe and verify that the other equipment is operating normally. Electromagnetic disturbance, may affect the lifting performance of the product. Modification using other parts than original spare parts (cables etc.) may affect the electromagnetic compatibility of the product. Particular care must be observed when using strong sources of potential disturbance, such as diathermy, etc, so that diathermy cables are not positioned on or near the product. If you have questions, please consult the responsible assistive device technician or the supplier.

2.2 Maximum load

A Liko™ lift system is a combination of products. Each product has its own maximum load marking. The lowest specified maximum load of the products that comprises the system sets the maximum load for the complete lift system. The lift system can contain following products; lift rails, a lift motor, a sling bar, a sling or other recommended accessories. Identify the maximum load for the complete lift system by reading the maximum load marking on each product in the system. Contact your Hill-Rom representative for support and advice.

 The total maximum load for a lift system is always determined by the product in the system with the lowest specified maximum load.

Example: Determine the maximum load for the lift system below.

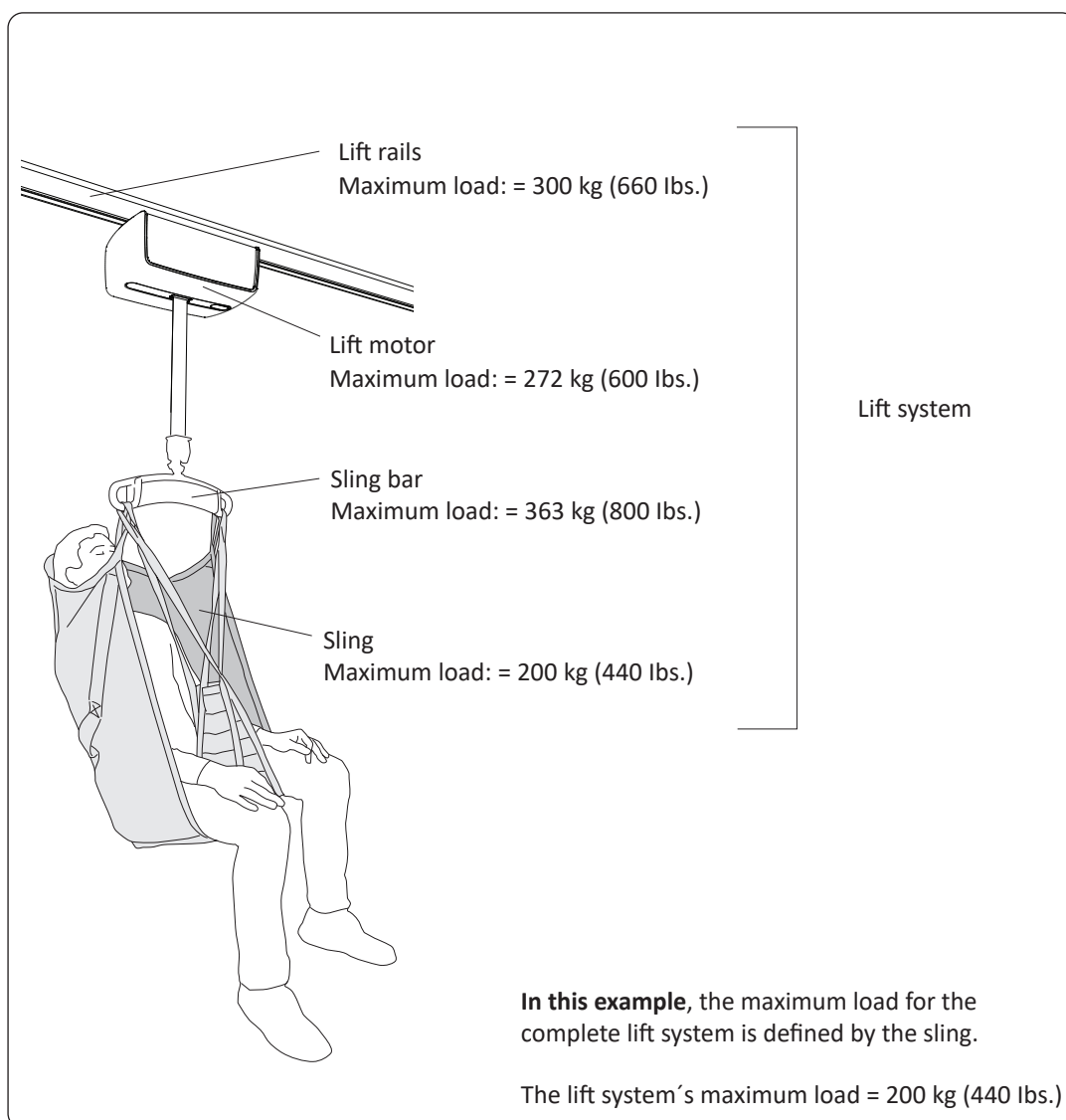

3. Instructions for use

Before using the lift, the user must be informed of the correct operation of the lift and accessories.
Read the instructions for use for both the lift and lifting accessories.



Never leave children unattended in the vicinity of the lift!

(Children will be exposed to risks that may lead to fatal injury i.e children falls.)



The hand control and cord must always hang free from the lift with no contact with surrounding objects during movement of a patient.



Always check the lift system according to "3.1 Check before every lift"

3.1 Check before every lift

Reviewing the lift strap, check that:

- the lift strap is free from wear or damage.
- the lift strap is hanging vertically and can move freely.
- the lift strap is not twisted and can enter the lift unit without problem.

Reviewing the sling bar, check that:

- the sling bar is correctly assembled.
- the sling bar is free from wear or damage.
- the sling bar latches are functioning.
- the sling bar hangs in level and can move freely.

Reviewing the sling, check that:

- the sling selected is appropriate in terms of type, size, material and design with regard to the patient's needs.
- the sling is being used correctly and safely, see instructions for use for respective sling.
- the sling is correctly applied to the patient, see instructions for use for respective sling.
- the sling is free from wear or damage, see instructions for use for respective sling.
- the strap loops of the sling are properly connected to the sling bar hooks, see instructions for use for respective sling.

Reviewing of other accessories, check that:

- the lifting accessories are properly attached to the lift.
- the lifting accessories are correctly chosen in relation to the patient's needs.
- the lifting accessories are not damaged.
- the lifting accessories hang vertically and can move freely.

3.2 Move the lift correctly

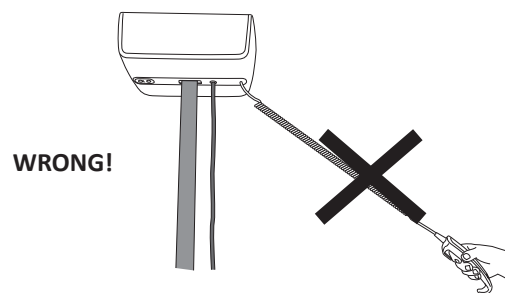
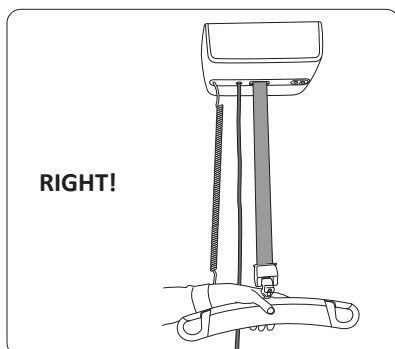

3.3 Leave the lift in the correct position after use

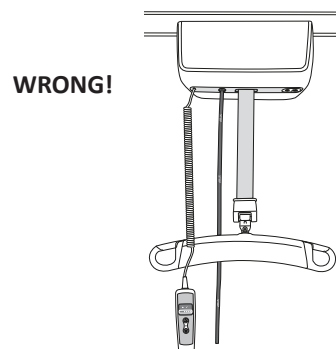
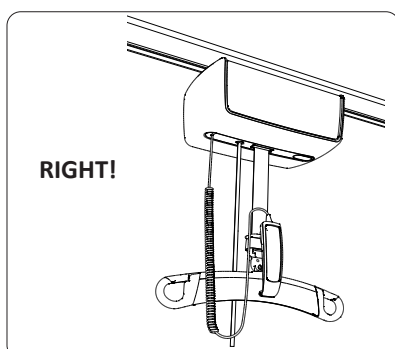

3.4 Choosing the correct sling

Liko has a broad assortment of slings in a variety of models. Our basic models cover the most common lifting needs while our special designed models are for our users with special needs. All slings have their own unique characteristics and are available in variety of sizes. To choose the correct model and size of the sling is of highest importance for safety, function and comfort for the user. For guidance and support in choosing the correct sling, contact your Hill-Rom representative.

Note! Always read the instructions for use that comes with Liko's different sling models for correct and safe use of the sling.

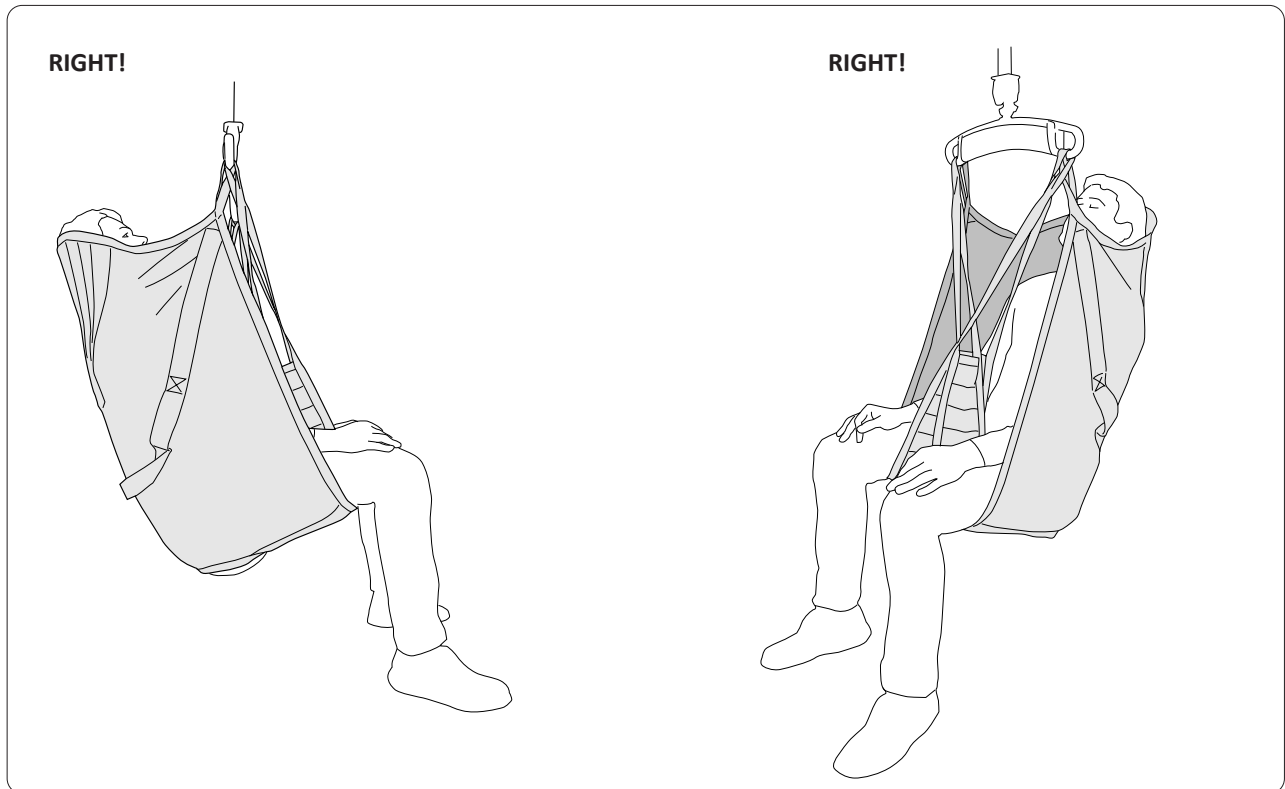

WRONG!

If the sling is too big there is a risk that:

The patient can slip out of the sling see Fig. 5.



Fig. 5

WRONG!

If the sling is too small there is a risk that:

The patient's head will not be supported and may end up close to the sling bar. The sling may seem tight to the patient, see Fig. 6.

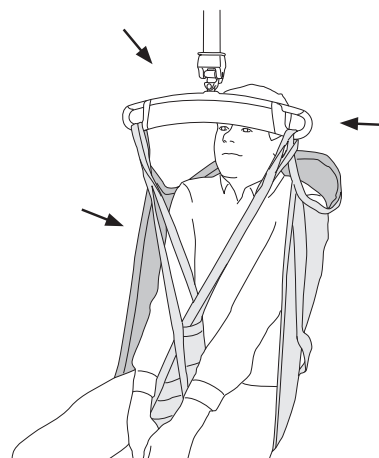

Fig. 6

3.5 Plan the transfer

It is important to plan the lifting operation so it will be as smooth and safe as possible.

Consider the following points before the lifting operation:

- Always work ergonomically. Use the patient’s ability to actively participate in the operation.
- Make sure the patient is sitting securely in the sling before transferring to another location.
- Never lift a patient higher off of the underlying surface than necessary to complete the lifting and transfer procedure.
- Never move a patient further than necessary
- Changes to surrounding areas i.e arrange in furniture may cause interference.



Never leave a patient unattended during a lifting situation!

When lifting into or out of bed:

Work from the long side of the bed.

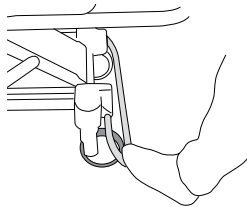
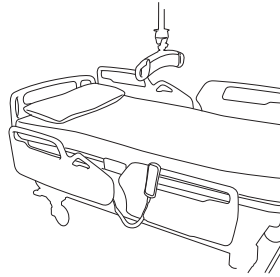

- Lock the bed wheels.

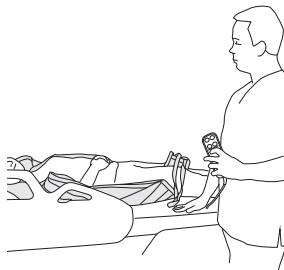

- Raise the bed to a comfortable working height when applying the sling.
- Follow the instructions in the instructions for use for the respective slings regarding correct application and use.

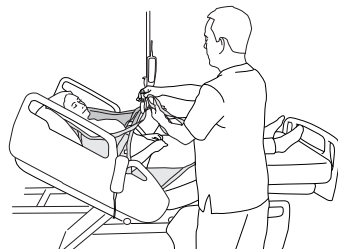

- If possible, raise the back of the bed before commencing the lift.



- Lower the bed during the lifting and transferring of the patient in order to minimize the distance between the patient and the floor during the lifting operation.

When lifting into or out of a chair/ wheelchair:

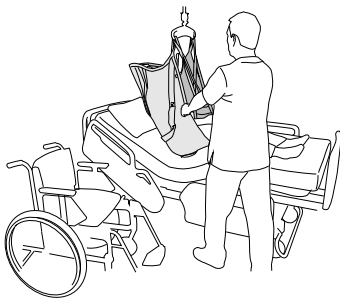
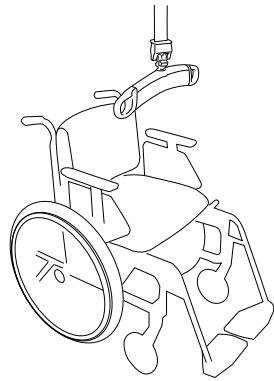

- Position your chair so that the distance of the movement is minimized.
- Lock the wheels of the wheelchair during transfers to or from a wheelchair.

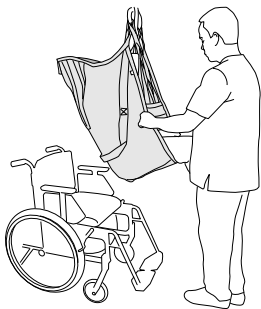

- Position the patient above the chair lift point, (Locked wheels on the wheelchair).

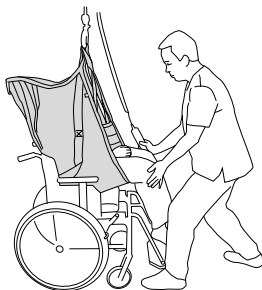

- Apply support to the patient's knees to ensure the patient is supported by the chair back once lifting is completed.

3.6 Apply the sling to the patient

Read the instruction for use for the respective sling regarding correct application and use.

3.7 Connect the sling to the sling bar

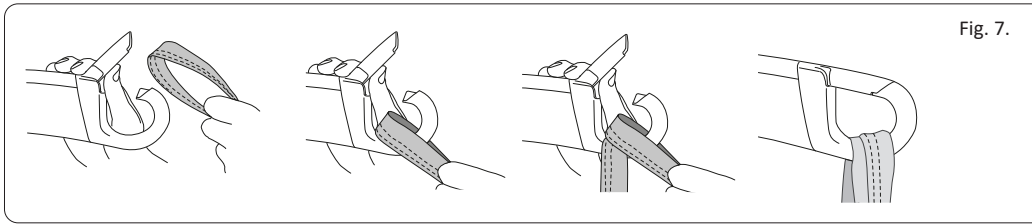

- In order to attach the sling correctly to the patient and the sling bar, always study the instructions for use for the sling to be used in that instance.
- Lift the latches to open the sling bar hooks, see Fig. 7, (first attach the upper strap loops and then the leg support loops to each sling bar hook)
- The sling is correctly attached when the sling bar hangs in level, see Fig. 8
- If the sling bar is not in level, see Fig. 9. refer to the instructions for use for the sling in use.

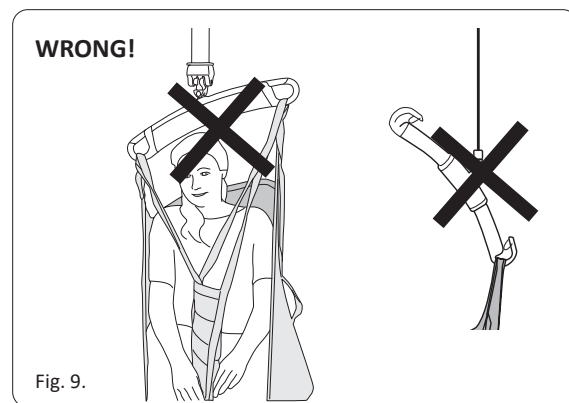

The sling strap loops must be attached to the sling bar hooks so that the sling bar latches close completely, preventing involuntary unhooking of the sling strap loops.

3.8 Before lifting the patient from the surface:

1. Check that the lift strap is hanging vertically, is not twisted or askew, see Fig. 10, 11, 12.

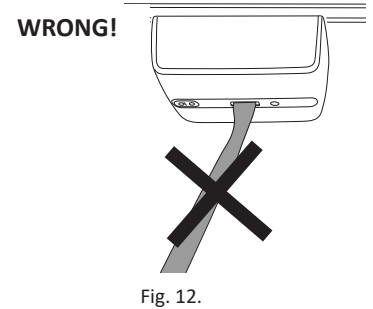
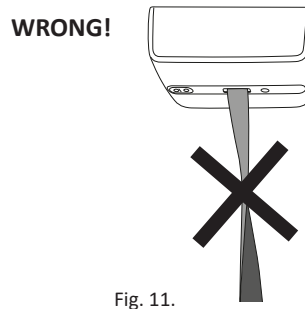
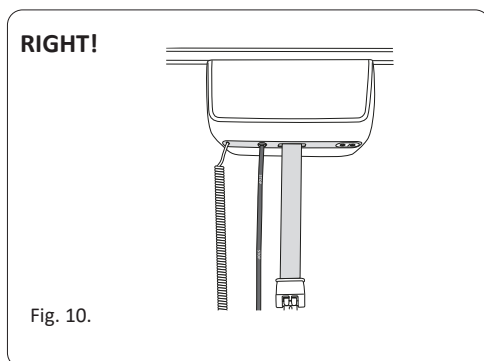

2. Raise the sling bar so that the sling's straps are taut but without lifting the patient from the surface. Check that the strap loops are properly attached to the sling bar hooks, see Fig. 13.

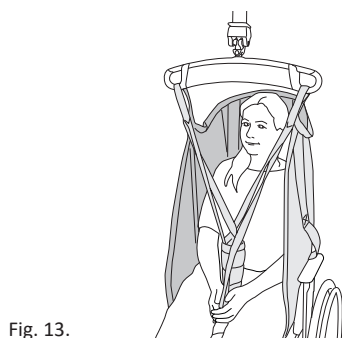

4 Functions and controls

4.1 Hand control

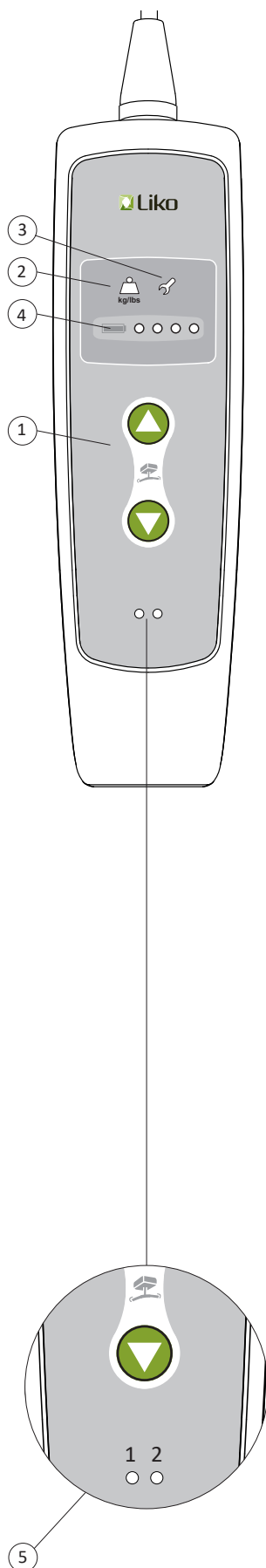

1. Operation



Up

Lift movement is based on the hand control being held in the direction shown in the picture. The movement stops when the button is released.

Down

Lift movement is based on the hand control being held in the direction shown in the picture. The movement stops when the button is released.

2. Overloading by weight (the lift stops) or Duty cycle exceeded

The lift's maximum load has been exceeded!

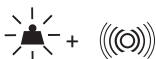

The lift will stop, a signal sounds, and the symbol lights up yellow. When the symbol goes out and the signal no longer sounds, the lift can be used again. Check the load and whether the lift system is being affected by surrounding objects.

The lift's Duty cycle has been exceeded!



The symbol flashes yellow.

- The lift's time in operating mode has been exceeded!

Lower the patient to a secure surface. Allow the lift to rest for around 40 minutes or until the symbol is no longer flashing if any of the up or down buttons are pressed. When the symbol goes out, the lift can be used again.

Duty cycle

Duty cycle includes the time the lift can be used in continuous operation and the subsequent inactive period required for the engine to cool down.

3. Service information

Service period!  The symbol lights up yellow.

















- contact your Hill-Rom representative for service of the lift.

Read more about service under "7.2 Service and 7.3 Service agreement" on page 22.

The lift may be used as normal during this period.

4. Battery information

The lift's battery power is indicated by 4 lamps. Example: battery power is 100 % when all lamps (1 - 4) lights, when only the lamp (1) lights, maximum 25% of battery power remains. Note! If the lamp (1) blinks and a signal  sounds, the lift should be charged at once.

	1	2	3	4	
					25%
					50%
					75%
					100%

5. Charging Information

When the hand control is connected to the wall charger the lights indicates:



Light 1 indicates yellow when the charger is connected to mains connection
Light 2 indicates yellow when charging is ongoing



Light 2 indicates green when the battery is fully charged.

Read more at 4.4 "Charging the lift battery", on page 18.

4.2 Hand control with display

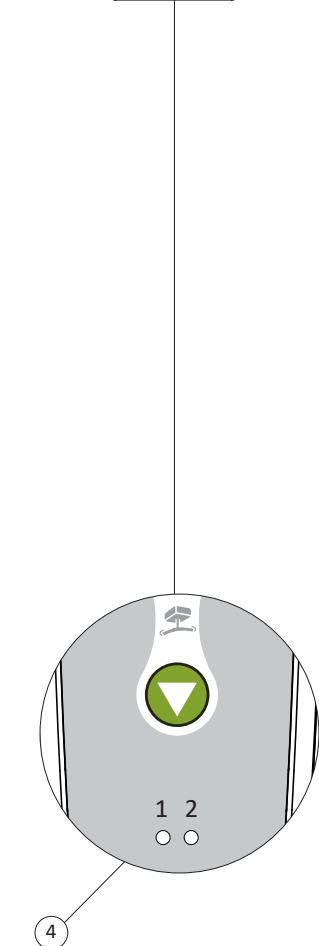
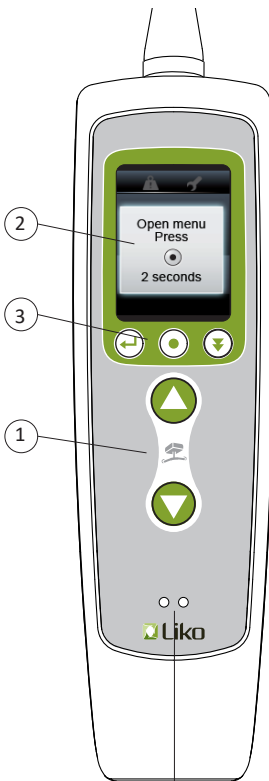

1. Operation



Up

Lift movement is based on the hand control being held in the direction shown in the picture. The movement stops when the button is released.



Down

Lift movement is based on the hand control being held in the direction shown in the picture. The movement stops when the button is released.

2. Display

Display window consists of two fields.

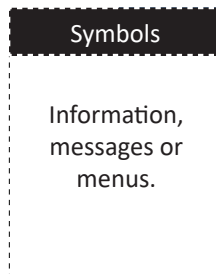

The small field: shows symbols

The large field: shows different information, messages or menus. Read more on page 17.

When the lift is in use the display window shows remaining battery power. The battery power is indicated by four fields. Example, battery power is 100% when all 4 fields are displayed. If only one field is displayed, maximum 25% of battery power remains. Note! If "Low battery" is displayed and a signal ((C)) sounds, the lift should be charged at once, less than 10% battery power remains.

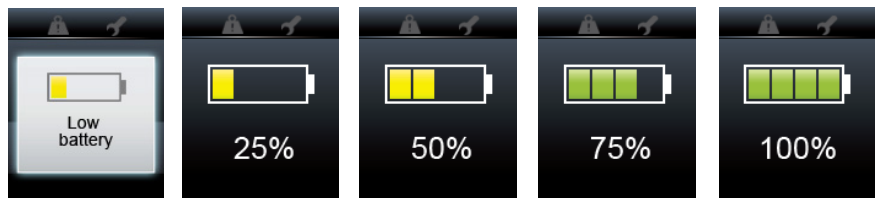

3. Manage display information in menus

"Back" "Select" "Navigate"



4. Information when charging

Indicating lights on hand control:

1 2
 Light 1 indicates yellow when the charger is connected to mains connection.

1 2
 Light 2 indicates yellow when charging is ongoing

1 2
 Light 2 indicates green when the battery is fully charged.

Read more at 4.4 "Charging the lift battery", on page 18.

4.3 Menus and information

The hand controls display has a usage menu and service menu. In the usage menu two types of usage history can be displayed. The first is the history of lifts performed in the past 7 day's period. A heavy lift is at minimum 200 kg (440 lbs.). To start gage 7 days from a given day, just reset the 7 day interval at the day for the gage to start. Read more about heavy lifting at page 8, 2.1 Intended use.

The second usage history is for every lift performed regardless of weight since the lift was taken in use the first time.

In the Service menu, settings of 14 different languages to choose among is available. The Service menu also contain information regarding when the next service is due.

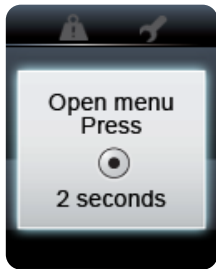

- To display the menus; Hold down the button  on the hand control for 2 seconds.

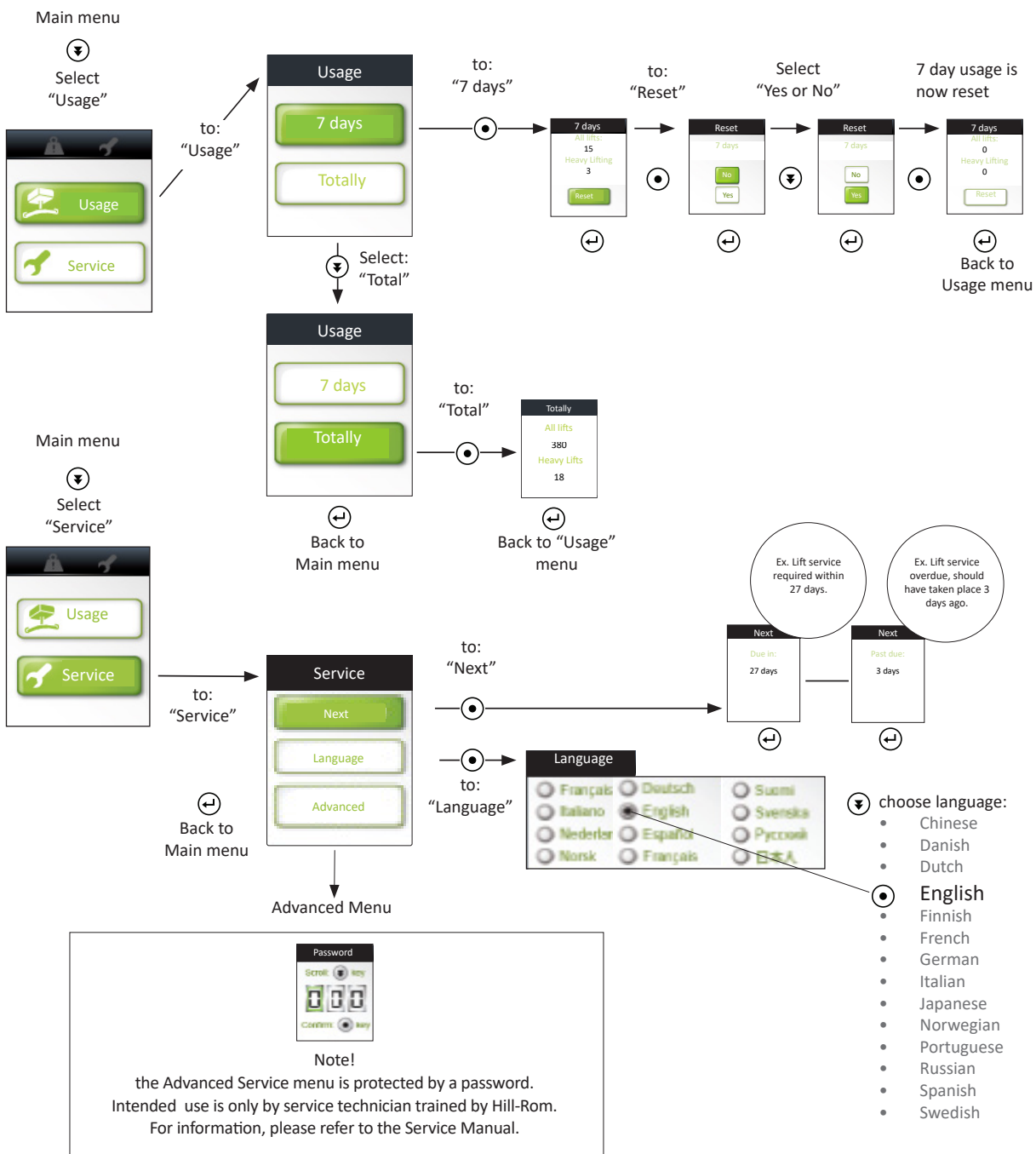

Battery power information.

When the lift is in use, the battery power status is displayed at the hand control's display window.

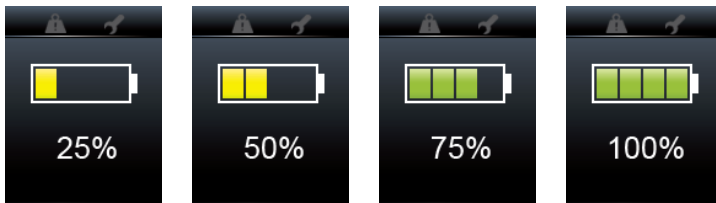

Symbols and Information

A pop-up message is displayed on screen for 5 seconds or until any button on the hand control is pressed.

To Menus

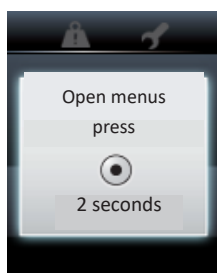

- To display menus Usage or Service; Hold in the -button on the hand control for 2 seconds.

Service required

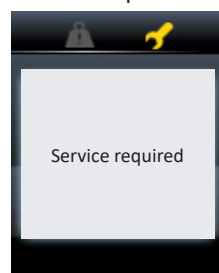

The symbol lights yellow.
 - Book a time for service, contact Hill-Rom.
Read more about service at; 7.2 "Service" and 7.3 "Service agreement" on page 22.
 The lift may be used as normal during this period.

Overload! (maximum load)

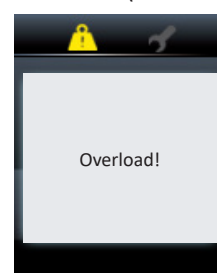

The symbol lights yellow and a signal sounds. The lift stops.
 Check the load and Check that the lift is not stucked to any surrounding objects.
 When the symbol goes out and the sound signal goes off, the lift can be used again.

Overload (Duty Cycle)

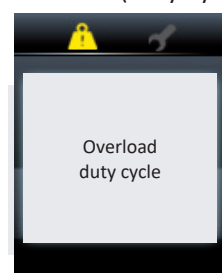

The symbol flashes yellow.
 - The lift's Duty Cycle has been exceeded. The lift may be used to lower the patient to a secure surface. Allow the lift to rest for around 40 minutes or until the message is no longer displayed when the button or is pressed.
 When the symbol goes out, the lift can be used again.
Read more about Duty cycle at pages 14 and 24.

Low battery!

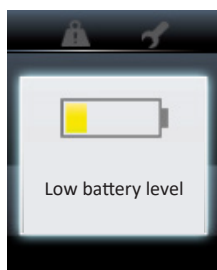

- The battery should be charged at once.

No contact!



- Hand control has no contact with the lift.

Emergency stop activated!

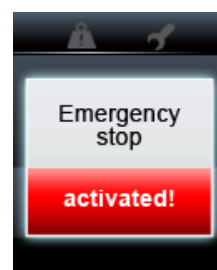

- Press in the emergency stop button on the underside of the lift to reset. (marked)



No lifting allowed!

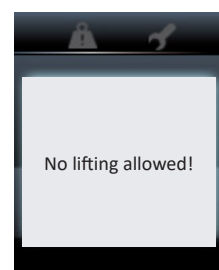

- An operational fault has occurred. No lifting is allowed, lower the patient to a secure surface.
 Contact your Hill-Rom representative for service.

4.4 Charging the lift battery

It is important that the lift battery is charged regularly. Always activate the lift's charging system when not in use. Full charge is achieved after maximum 6 hours. With a fully charged battery approximately 35 normal* lifts with a load of maximum 100 kg (220 lbs.) can be carried out. Regular charging is important to maximize battery life.

*A normal lift = 70 cm (27.6 in) up on which 40 cm (15.7 in) is with a load, followed by 70 cm (27.6 in) down of which 40 cm (15.7 in) is with a load.

NOTE! When the lift is not in use activate the lift charging system. If the charger cannot be used, the emergency stop function should be activated to prevent draining the battery.

The lift cannot be charged with the emergency stop activated.

Charging with a wall charger (Prod. No. 3305010-3305050)

1. - Check that the lift's emergency stop is not activated
- Check that the switch on the wall chargers right-hand side is switched on, see Fig.1. (The switch can function as an emergency circuit breaker in the event that a fault occurs).
2. Place the hand control in the wall charger
3. Light (1) on the hand control indicates yellow when the charger is connected to the mains connection, see Fig. 2.
4. The charger starts automatically and the light (2) indicates yellow when charging is ongoing, see Fig. 2.
5. When the battery is fully charged the charger automatically disconnects and the light (2) on the hand control indicates green see Fig. 2.

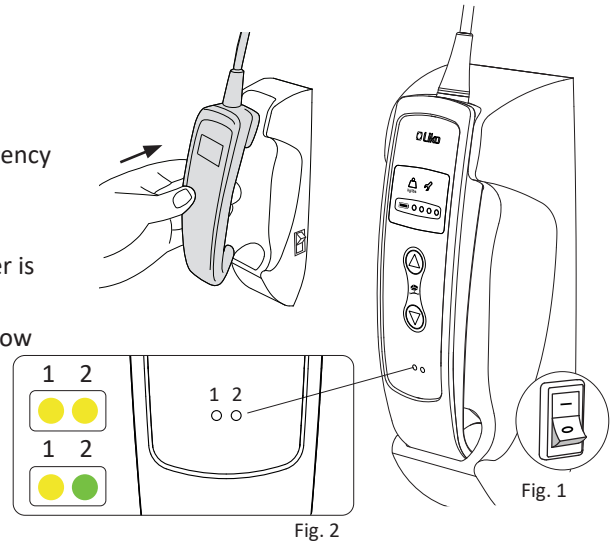

Never use power sources other than the Liko™ recommended. See technical data page 24.

4.5 Alternative charging system.

The Liko In-Rail Charging system is an easy to use charging solution that continuously charges the lift when it is not in use. When lift is in use, the charging stops and will automatically resume in about 5 min after finished use.

Hand control indicators, see 4.4 Fig 2.

- | | |
|---------|---------------------------------------------------------------------------------------------------------------------------------|
| 1 2
 | Light 1 indicates yellow when the charger is connected to mains connection
Light 2 indicates yellow when charging is ongoing |
| 1 2
 | Light 2 indicates green when the battery is fully charged. |

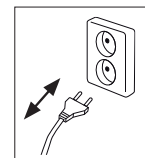

Access to the mains connection shall not be blocked; to pull out the plug can in the event of a fault, be used as a circuit breaker!

For more information, contact your Hill-Rom representative.

4.6 Limit Switch

The lift motion stops by a light touch to the Limit Switch. If the lift strap is fully rewound, pulled sideways or folded over during lifting so the Limit Switch is activated, the lift motion stops. If the Limit Switch has been activated the lift can be restarted as soon as an example; the lift strap not activates the limit switch, in these cases a short response delay is normal during restart.

Be aware that the lift strap must be kept straight and taut when it runs in and out of the lift unit.

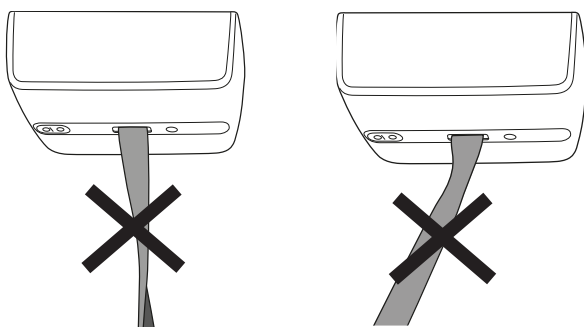

4.7 Operation panel on lift

If needed, the lifting motion can also be controlled without the hand control via the respective ▲ and ▼ buttons on the operation panel.

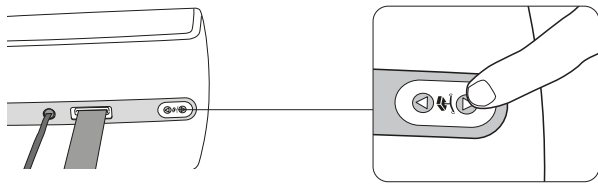

4.8 Emergency stop

Activate emergency stop: Pull out the emergency stop button using the red emergency stop cord.

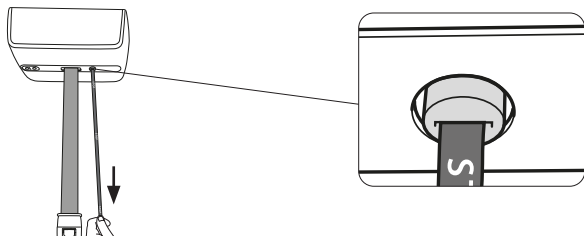

Reset emergency stop: Push in the emergency stop button.

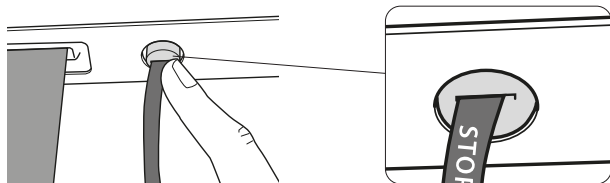

4.9 Emergency lowering

Mechanical emergency lowering;

1. Pull down and 2. Drop the red emergency stop band, see Fig. 3a and 3b.

Repeat 1 -2 until the patient has been lowered down to solid and secure base, and the lift strap is slack.

Note! Apply load during a functionality check by pulling gently with one hand in the lift strap.

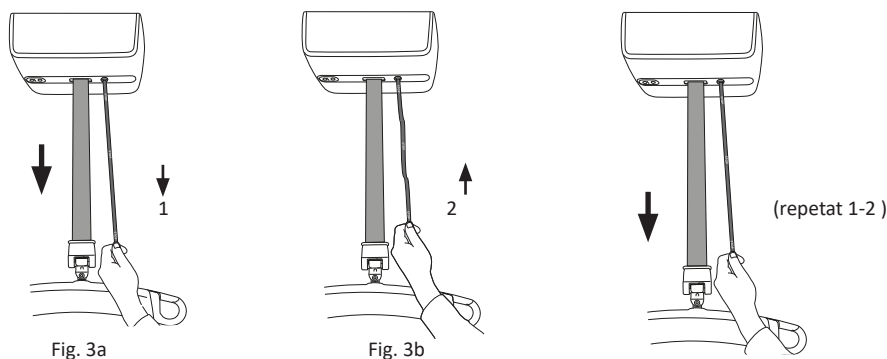

Electrical Emergency lowering; use hand control or the operation panel at the lift motor. Note! The Emergency Stop shall not be activated! Press the down button ▼ to lower the patient to secure surface and the lift strap is slack, see page 19 “4.7 Operation panel on lift”, or page 14 “4.1 Hand control”.

4.10 Quick attachment device



Always check that accessory with a quick attachment device is correctly attached to the lift strap attachment.

Pull out the green button on the Quick-Hook Multi, see Fig. 4a. Attach the quick hook to the Multi-Link on the lift strap and release the button. Quick-Hook Multi is now attached and locked to the the lift straps Multi-Link, see Fig. 4b.

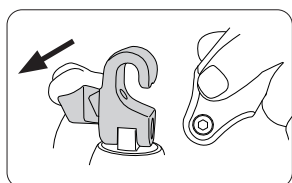

Fig. 4a

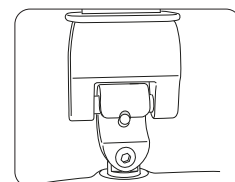
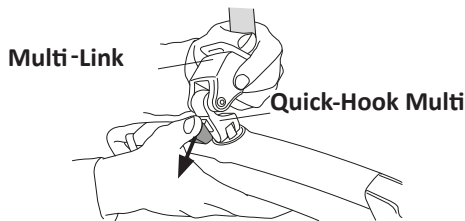
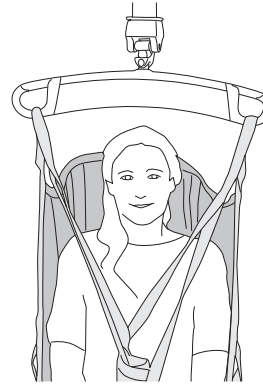
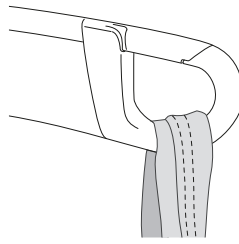
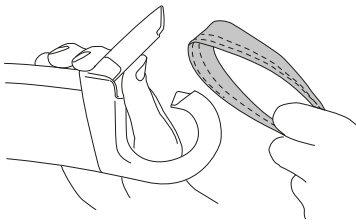

fig. 4b

4.11 Latches on sling bar



5. Recommended lifting accessories

For guidance and support in choosing the correct sling, contact your Hill-Rom representative.

 To use other lifting accessories than those recommended by Liko™ can entail risk.

(Patient will be exposed to risks that may lead to fatal injury i.e patient falls.)

Below you find lifting accessories suitable for the LikoGuard™ Overhead lift.

SlingGuard™ 450 with Quick-Hook Multi
Maximum load 363 kg (800 lbs.)

Prod. No. 3308520

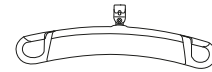

SlingGuard™ 450
Maximum load 363 kg (800 lbs.)

Prod. No. 3308020

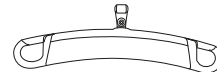

Sling Cross-bar 450
Maximum load 300 kg (660 lbs.)
(Requires, Fixed kit 4, Prod. No. 3308860)

Prod. No. 3156021

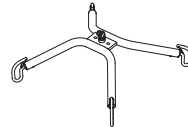

Sling Cross-bar 670
Maximum load 300 kg (660 lbs.)
(Requires, Fixed kit 4, Prod. No. 3308860)

Prod. No. 3156018

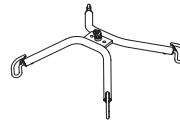

FlexoStretch™
Maximum load 300 kg (660 lbs.)
(Requires, Fixed kit 4, Prod. No. 3308860)

Prod. No. 3156057



LikoStretch™ Mod 600 IC
(B = wider model)
Maximum load 250 kg (550 lbs.)
(Requires, Fixed kit 4, Prod. No. 3308860)

Prod. No. 3156065B

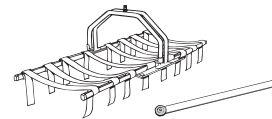

OctoStretch™
Maximum load 200 kg (440 lbs.)
(Requires, Fixed kit 4, Prod. No. 3308860)

Prod. No. 3156056



LikoScale™ 350
(Requires Quick-Hook Kit 1 Prod. No. 3308810 or Fixed Kit 1, Prod. No. 3308820)

Prod. No. 3156228

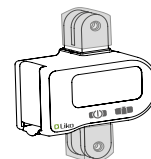

For United States and Canada only:

LikoScale 200, Max. 200 kg (440 lbs.)

Prod. No. 3156225

LikoScale 400, Max. 400 kg (880 lbs.)

Prod. No. 3156226

(Requires Quick-Hook Kit 1 Prod. No. 3308810 or Fixed Kit 1, Prod. No. 3308820)

Contact your Hill-Rom representative for more information.



SlingGuard™ 670 Twin
Maximum load 363 kg (800 lbs.)

Prod. No. 3308040

SlingGuard™ 670 Twin with Quick-Hook Multi
Maximum load 363 kg (800 lbs.)

Prod. No. 3308540

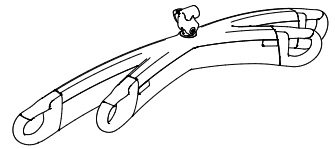

6. Trouble shooting

The lift does not work

1. Check that the Emergency Stop button is not activated.
 2. Charge the LikoGuard™ Overhead lift.
 3. If the lift still does not work satisfactorily, please contact Hill-Rom.
-

A repeated signal can be heard from the lift

1. Charge the LikoGuard™ Overhead lift immediately.
 2. If the lift still does not work satisfactorily, please contact Hill-Rom.
-

The lift stops in the high position

1. Check that the Emergency Stop button is not activated.
 2. Use the mechanical or the electrical emergency lowering device to lower the patient onto a firm surface.
 3. Charge the LikoGuard™ Overhead lift.
 4. If the lift still does not work satisfactorily, please contact Hill-Rom.
-

The lift does not achieve maximum lifting capacity

1. Charge the LikoGuard™ Overhead lift.
 2. If the lift still does not work satisfactorily, please contact Hill-Rom.
-

In the event of excessive noise from the lift!

Please contact Hill-Rom.

7 Inspection and maintenance

7.1 Care and maintenance

For trouble-free use, certain details should be checked daily prior to using the lift:

- Inspect the lift and check to make sure that there is no external damage.
- Check the sling bar attachment.
- Check the lift strap for wear and to ensure the strap is not twisted.
- Check the functionality of the latches.
- Check the lifting movement function, up and down, at both hand control and the operation panel at the lift.
- Check to make sure that the electrical emergency lowering is functioning.
- Check to make sure that the mechanical emergency lowering is functioning, see "4.9 Emergency lowering" page 19.
- Charge the batteries each day the lift is used and check to ensure the charger works.

When required, clean the lift by wiping down with a cloth moistened with warm water.

For detailed information regarding cleaning and disinfecting of your Hill-Rom product see the section "Cleaning and disinfection" on pages 28-29.

The lift should not be exposed to running water.

7.2 Service

The LikoGuard™ Overhead lift should be subjected to periodic inspection, at least once a year. Service is not allowed with patient in lift.



Inspection and maintenance of this product shall be made by personnel trained by Hill-Rom using Liko™ original spare parts and according to the Liko™ Service Manual.



Replacing the lithium battery can cause injury and shall always be done by Hill-Rom trained personnel.

7.3 Service agreement

Hill-Rom offers service contracts for the maintenance and periodic inspection of your Liko products.

7.4 Expected life time

The product has an Expected Life Time of 10 years when correctly handled, serviced and inspected in accordance with Liko product instructions. Read more about this product's Expected Life Time in section "2.1 Intended Use" at page 7.



The product should be used in accordance with the recommendations for Expected Life Time.



Parts that are subject to wear and tear shall be replaced if damaged or if a specific expected life time have exceeded!

Parts listed below are subject to wear and tear and have specific expected life time:

- Lift strap, expected life time 5 years.

7.5 Transport and storage

The environment where the lift is stored should have a temperature of -25° C to +40° C at a relative humidity up to 93 %, non-condensing. The environment where the lift is transported should have a temperature of -25° C to +70° C at a relative humidity from 15 % - 93 %, non-condensing. Atmospheric pressure range of 700 hPa to 1060 hPa.



During transport and storage the product must be handled according to; 7.5 Transport and storage.

7.6 Product changes

Liko's products undergo continuous development, which is why we reserve the right to make product changes without prior notice. Contact your Hill-Rom representative for advice and information about product upgrades.

Design and Quality by Liko in Sweden

Hill-Rom's Management system are certified in accordance with ISO 9001 and its equivalent for the medical device industry, ISO 13485. Hill-Rom's Management system is also certified in accordance with environmental standard ISO 14001.

7.7 Notice to Users and/or Patients in EU

Any serious incident that has occurred in relation to the device, should be reported to the manufacturer and the competent authority of the Member State in which the user and/or patient is established.

7.8 Recycling Instructions

Hill-Rom evaluates and provides guidance to its users on the safe handling and disposal of its devices to aid in the prevention of injury, including, but not limited to: cuts, punctures of the skin, abrasions, and any required cleaning and disinfection of the medical device after use and prior to its disposal.

Customers should adhere to all federal, state, regional, and/or local laws and regulations as it pertains to the safe disposal of medical devices and accessories. If in doubt, the user of the device shall first contact Hill-Rom Technical Support for guidance on safe disposal protocols.

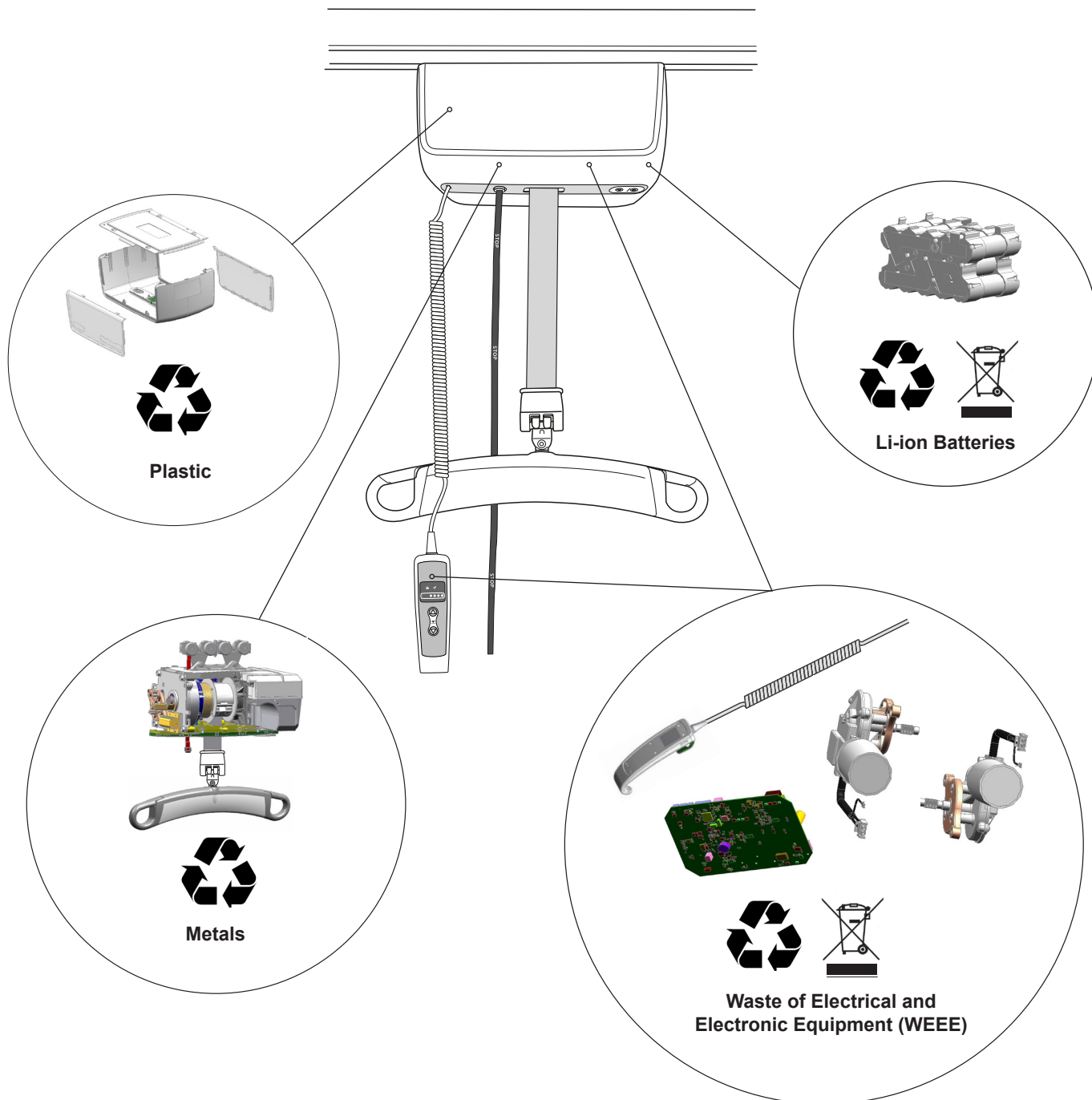



The LikoGuard™ Overhead lift complies with the Directive 2012/19/EEC on waste electrical and electronic equipment. Old batteries are to be deposited at the nearest recycling facility in accordance with local regulations or given to personnel trained by Hill-Rom.

8 Product data

8.1 Technical specifications

Maximum load	L: 272 kg (600 lbs.) XL: 363 kg (800 lbs.)	Emergency lowering device:	Mechanical Electrical
Battery:	25.2V / 4.2 Ah	Emergency raising:	Electrical
Battery charger:	Built-in battery	Duty cycle:	10/90 max. 2 min (0 - 272 kg) (0 - 600 lbs.) (Intermittent power) 5/95 max. 2 min (>272 - 363 kg) (> - 800 lbs.)
Power source:	Wall charger, Art. No. 3305010 - 3305050 Input: 100-240 VAC, 50/60 Hz, 0.9 A Output: 33.5 VDC, 1.36 A IRC charger, Art. No. 3305510 - 3305550 Input: 100-240 VAC, 50/60 Hz, 1.2 A Output: 27.6-29.5 VDC, 1.5 A	Sound level:	70 dB(A)
Lifting speed:	5-6 cm/sec with a load between 0 - 100 kg (2 - 2.3 inch./sec. with a load between 0 - 220 lbs.) 4-6 cm/sec with a load between 100 kg or more (1.6 - 2.3 inch./sec. with a load between 220 lbs. or more)	Lift motor	
Lifting interval:	Min. 2300 mm	Protection class:	IP X4 (humidity resistance)
Electrical data:	25.2 V / 30 A	Hand control	
Fuse:	Type: 0287020 Voltage: 32VDC Breaking capacity: 1000A Operation Speed: 150ms-5s	Protection class:	IP X7 (humidity resistance)
Liftmotor		Operating forces of controls:	4.9 N
Weight:	14 kg (31 lbs.)	Surrounding functional environment:	Temp. +5 ° C till +40 ° C, relative humidity 15% to 93% non-condensing. Atmospheric pressure range of 700 hPa to 1060 hPa.

 Intended for indoor use.

 Protection class against electric shock Type B.



This product shall only be used in the recommended environment.

8.2 Dimensions

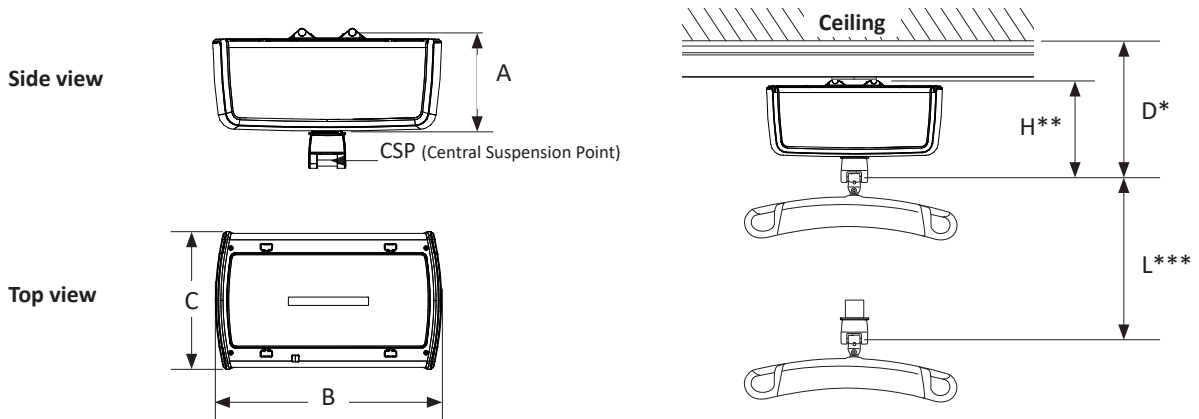

Measurements in mm.

A	B	C	D*	H**	L***
178	410	250	323	232	2300

Measurements in Inch.

A	B	C	D*	H**	L***
7	16.1	9.8	12.7	9.1	90.6

* Min. distance from ceiling to CSP at max. lifting height.

** Installation dimensions: the distance between the attachment point for the lift unit on the carriage and the CSP at max. lifting height.

*** Lifting interval: the distance between max. lifting height and min. lifting height measured in CSP.



The LikoGuard™ overhead lift have been tested by an accredited testing institute.

8.3 Electromagnetic emission

Guidance and manufacturer's declaration – electromagnetic emissions		
This product is intended for use in the electromagnetic environment specified below. The customer or the user of this product should assure that the product is used in such an environment.		
Emissions test	Compliance	Electromagnetic environment - guidance
RF emissions CISPR 11	Group 1	The use of RF energy is only for its internal function. Therefore, its RF emissions are very low and are not likely to cause any interference in nearby electronic equipment.
RF emissions CISPR 11	Class B	Suitable for use in all establishments including domestic establishments and those directly connected to the public low-voltage power supply network that supplies buildings used for domestic purposes.
Harmonic emissions IEC 61000-3-2	Complies	
Voltage fluctuations/ flicker emissions IEC 61000-3-3	Complies	

8.4 Electromagnetic immunity

Any unintentionally movement by the tested unit is not allowed for a EMC pass criteria.

Guidance and manufacturer's declaration – electromagnetic immunity			
This product is intended for use in the electromagnetic environment specified below. The customer or the user of this product should assure that the product is used in such an environment.			
Immunity test	IEC 60601 test level	Compliance level	Electromagnetic environment - guidance
Electrostatic discharge (ESD) IEC 61000-4-2	+/- 8 kV contact +/- 15 kV air	+/- 8 kV contact +/- 2, 4, 8, 15 kV air	+/- 8 kV contact +/- 15 kV air, relative humidity should be at least 15 %.
Electrical fast transient / Burst IEC 61000-4-4	+/- 2 kV for power supply lines +/- 1 kV for input/output lines	+/- 2 kV for power supply lines n/a. for input/output lines	Mains power quality should be that of a typical commercial, hospital or home healthcare environment
Surge IEC 61000-4-5	+/- 1 kV differential mode +/- 2 kV common mode	+/- 0,5 and 1 kV differential mode n/a. for common mode	Mains power quality should be that of a typical commercial, hospital or home healthcare environment
Voltage dips, short interruptions and voltage variations on power supply input lines IEC 61000-4-11	0 % UT for 0,5 cycle at 0°, 45°, 90°, 135°, 180°, 225°, 270° and 315° 0% UT; 1 cycle at 0°C 70 % UT for 25 cycles 50Hz 30 cycle at 60Hz at 0° 0% UT; 250 cycle at 50Hz and 300 cycle at 60 Hz		Mains power quality should be that of a typical commercial, hospital or home healthcare environment. If the user of lift requires continued operation during power mains interruptions, it is recommended that the mobile lift be powered from an uninterrupted power supply or battery.
Power frequency (50/60 Hz) magnetic field IEC 61000-4-8	30 A/m	Complies	Power frequency magnetic fields should be at levels characteristic of a typical location in a typical commercial, hospital or home healthcare environment.
NOTE U_T is the a.c. mains voltage prior to application of the test level.			



Guidance and manufacturer's declaration – electromagnetic immunity

This product is intended for use in the electromagnetic environment specified below.
The customer or the user of this product should assure that the product is used in such an environment.

Immunity test	IEC 60601 test level	Compliance level	Electromagnetic environment - guidance
Conducted RF IEC 61000-4-6	6 Vrms 150 kHz to 80 MHz	6 Vrms 150 kHz to 80 MHz	Portable and mobile RF communications equipment should be used no closer to any part of the LR, including cables, than the recommended separation distance calculated from the equation applicable to the frequency of the transmitter. Recommended separation distance $d = 1.2 \sqrt{P}$ $d = 1.2 \sqrt{P} \quad 80 \text{ MHz to } 800 \text{ MHz}$ $d = 2.3 \sqrt{P} \quad 800 \text{ MHz to } 2,7 \text{ GHz}$ where P is the maximum output power rating of the transmitter in watts (W) according to the transmitter manufacturer and d is the recommended separation distance in meters (m). Field strengths from fixed RF transmitters, as determined by an electromagnetic site survey, ^a should be less than the compliance level in each frequency range. ^b Interference may occur in the vicinity of equipment marked with the following symbol. 
Radiated RF IEC 61000-4-3	10 V/m 80 MHz to 2,7 GHz	10 V/m 80 MHz to 2,7 GHz	

NOTE 1 At 80MHz and 800MHz, the higher frequency range applies.

NOTE 2 These guidelines may not apply in all situations. Electromagnetic propagation is affected by absorption and reflected from structures, objects and people.

^a Field strengths from fixed transmitters, such as base stations for radio (cellular/cordless) telephones and land mobile radios, amateur radio, AM and FM radio broadcast and TV broadcast cannot be predicted theoretically with accuracy. To assess the electromagnetic environment due to fixed RF transmitters, an electromagnetic site survey should be considered. If the measured field strength in the location in which the LR is used exceeds the applicable RF compliance level above, the LR should be observed to verify normal operation. If abnormal performance is observed, additional measures may be necessary, such as reorienting or relocating the LR.

^b Over the frequency range 150 kHz to 80 MHz, field strengths should be less than 10 V/m.

Recommended separation distances between portable and mobile RF communications equipment and the LikoGuard™ overhead lift

This product is intended for use in an electromagnetic environment in which radiated RF disturbances are controlled. The customer or the user of the lift can help prevent electromagnetic interference by maintaining a minimum distance between portable and mobile RF communications equipment (transmitters) and the lift as recommended below, according to the maximum output power of the communications equipment.

Rated maximum output power of transmitter (W)	Separation distance according to frequency of transmitter (m)		
	150 kHz to 80 MHz $d = 1,2\sqrt{P}$	80 MHz to 800 MHz $d = 1,2\sqrt{P}$	800 MHz to 2.7 GHz $d = 2,3\sqrt{P}$
0.01	0.12	0.12	0.24
0.1	0.38	0.38	0.73
1	1,2	1.2	2.3
10	3,8	3.8	7.3
100	12	12	23

For transmitters rated at a maximum output power not listed above, the recommended separation distance *d* in meters (m) can be estimated using the equation applicable to the frequency of the transmitter, where *P* is the maximum output power rating of the transmitter in watts (W) according to the transmitter manufacturer.

Note 1: At 80 MHz and 800 MHz, the separation distance for the higher frequency range applies.

Note 2: These guidelines may not apply in all situations. Electromagnetic propagation is affected by absorption and reflection from structures, objects and people.

For Radiated RF immunity test level:

$$E = \frac{6}{d} \sqrt{P}$$

Where *P* is the maximum power in W, *d* is the minimum separation distance in m, and *E* is the immunity test level in V/m. The factor of 6 is a compromise for a range of antenna factors, to simplify the test.

Guidance and manufacturer's declaration – electromagnetic immunity

The product is intended for use in the electromagnetic environment specified below. The customer or the user of the product should assure that it is used in such an environment.

"Essential performance according to the manufacturer: The product shall not move unintentionally while being submitted to disturbances."

Test frequency (MHz)	Band ^{a)} (MHz)	Service ^{a)}	Modulation ^{b)}	Maximum power (W)	Distance (m)	IMMUNITY TEST Level (V/m)
385	380 - 390	TETRA 400	Pulse modulation ^{B)} 18 Hz	1.8	0.3	27
450	430 - 470	GMRS 460, FRS 460	FM ^{C)} +/- 5 kHz deviation 1 kHz sine	2	0.3	28
710	704 - 787	LTE Band 13, 17	Pulse modulation ^{b)} 217 Hz	0.2	0.3	9
745						
780						
810	800 - 960	GSM 800/900, TETRA 800, IDEN 820, CDMA 850, LTE Band 5	Pulse modulation ^{b)} 18 Hz	2	0.3	28
870						
930						
1720	1700 - 1990	GSM 1800, CDMA 1900, GSM 1900, DECT, LTE Band 1, 3, 4, 25 UMTS	Pulse modulation ^{b)} 217 Hz	2	0.3	28
1845						
1970						
2450	2400 - 2570	Bluetooth, WLAN, 802.11 b/g/n, RFID 2450 LTE Band 7	Pulse modulation ^{b)} 217 Hz	2	0.3	28
5240	5100 - 5800	WLAN 802.11 a/n	Pulse modulation ^{b)} 217 Hz	0.2	0.3	9
5500						
5785						

NOTE If necessary to achieve the IMMUNITY TEST LEVEL, the distance between the transmitting antenna and the ME EQUIPMENT or ME SYSTEM may be reduced to 1 m. The 1 m test distance is permitted by IEC 61000-4-3.

a) For some services, only the uplink frequencies are included.

b) The carrier shall be modulated using a 50 % duty cycle square wave signal.

c) As an alternative to FM modulation, 50 % pulse modulation at 18 Hz may be used because while it does not represent actual modulation, it would be worst case.

9. Cleaning and disinfection



Cleaning and disinfection must always be carried out in accordance with this instruction.

All parts must always be kept clean in order to avoid the risk of infection. Necessary precautions must be taken to eliminate all visible stains and dirt. The cleaning and disinfection methods described are specifically aimed at the lift and all accessories. It has been designed to save time and contribute to effectively fight healthcare related infections.

9.1 Equipment

- Safety equipment should be used (such as rubber gloves, protective glasses, aprons, face masks/protective masks and overshoes) according to guidelines and routines in your organization and the manufacturer's instructions.
- Clean buckets
- Cloths
- Soft brushes
- Warm water
- See "9.4 Use of cleaning and disinfecting agents on the LikoGuard™ Overhead lift" on page 29 to find suitable cleaning and disinfecting agents.

9.2 Cleaning instructions

Cleaning of the lift and accessories should take place regularly based on use or the organizations requirements.

1. Disconnect the lift from the power source before beginning cleaning and disinfection.
2. Clean the lift with a cloth moistened with warm water and a neutral cleaning agent approved within your organization. A soft brush may be used to remove stains and resistant dirt.
3. Wipe off the entire lift starting from the top and working down. The cloth should not be so damp that it drips. Lower the sling bar to gain access to the entire lift strap. After cleaning the lift strap make sure that the strap is dry before raising the sling bar.



Do not use any of following agents on the lift strap or on the Emergency stop cord; CSI, Oxivir Tb, Dispatch, Chlor-Clean, Dismozon Pur or the equivalent.

4. Pay special attention to the following areas:

- Lift strap
- Operation panel
- Emergency stop button
- Emergency stop cord / Mechanical emergency lowering
- Sling bar
- Hand control

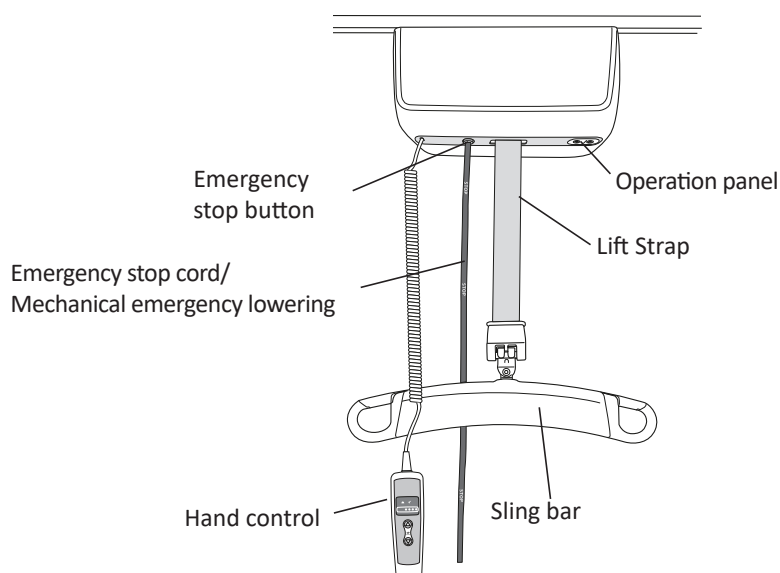

9.3 Disinfection instructions

Disinfection of the lift and lifting accessories should be carried out with risk of contagion or at regular intervals if required. Use a suitable disinfectant, see "9.4 Use of cleaning and disinfecting agents on the LikoGuard™ Overhead lift" on page 29 and repeat 9.2 Cleaning instructions. Follow the manufacturer's instructions for correct use of disinfectants. After disinfection wipe off the lift with a cloth moistened with clean water to remove traces of disinfectant.

9.4 Use of cleaning and disinfecting agents on the LikoGuard™ Overhead lift

Chemical class	Active ingredients	pH	Cleaning agent / Disinfectant *	Manufacturer *	May not be used on the following items:
Quaternary ammonium chloride	Didecyl dimethyl ammonium chloride = 8.704% Alkyl dimethyl benzyl ammonium chloride = 8.19%	9.0 – 10.0 when using	Virex II (256) (or equivalent)	Johnson/Diversey	
Quaternary ammonium chloride	Alkyl dimethyl benzyl ammonium chloride = 13.238% Alkyl dimethyl ethylbenzyl ammonium chloride = 13.238%	9.5 when using	HB Quat 25L (or equivalent)	3M	
Accelerated hydrogen peroxide	Hydrogen Peroxide 0.1-1.5% Benzyl Alcohol: 1-5% Hydrogen Peroxide 0.1-1.5% Benzyl Alcohol: 1-5%	3	Oxivir Tb (or equivalent)	Johnson/Diversey	Lift strap, (LikoGuard™) Emergency stop cord (LikoGuard™)
Phenolic	Ortho-Phenylphenol = 3.40% Ortho-Benzyl-para-Chlorophenol = 3.03	3.1 +/- 0.4 when using	Wexicide (or equivalent)	Wexford Labs	
Bleach	Sodium hypochlorite	12.2	Dispatch (or equivalent)	Caltech	Lift strap, (LikoGuard™) Emergency stop cord (LikoGuard™)
Alcohol	Isopropyl alcohol = 70%	5.0 – 7.0	Viraguard (or equivalent)	Veridien	
Quaternary ammonium	n-Alkyl dimethyl benzyl ammonium chlorides = 0.105% n-Alkyl dimethyl ethylbenzyl ammonium chlorides = 0.105%	11.5 - 12.5	CSI (or equivalent)	Central Solutions Inc.	Lift strap, (LikoGuard™) Emergency stop cord (LikoGuard™)
Benzyl-C12-18-alkyldimethylammonium, chlorides	Benzyl-C12-18-alkyldimethylammonium, chlorides (22%) 2-Phenoxyethanol (20%) Tridecylpolyethylenglycolether (15%) Propan-2-ol (8%)	approx. 8.6 when using	Terralin Protect (or equivalent)	Shulke	
Organic peroxide (type E, solid)	Magnesium monoperoxyphthalate hexahydrate (50-100%) Anionic surfactant (5-10%) Nonionic surfactant (1-5%)	5.3 when using	Dismozon Pur (or equivalent)	Bode	Lift strap, (LikoGuard™) Emergency stop cord (LikoGuard™)
Ethanol	Hydrogen peroxide (2.5-10%) Lauryldimethylamine oxide (0-2.5%) Ethanol (2.5-10%)	7	Anioxy-Spray WS (or equivalent)	Anios	
Trosclosene sodium	Adipic acid 10-30% Amorphous silica < 1% Sodium Toluene sulfphonate 5-10% Trosclosene sodium 10-30%	4-6 when using	Chlor-Clean (or equivalent)	Guest Medical Ltd	Lift strap, (LikoGuard™) Emergency stop cord (LikoGuard™)

*) or equivalent



Liko AB
Nedre vägen 100
975 92 Luleå, Sweden
+46 (0)920 474700



Liko AB is a subsidiary of Hill-Rom Holdings, Inc.

www.hillrom.com

Enhancing outcomes for
patients and their caregivers:

