

Liko™ Ultra LiftPants™ Mod. 920

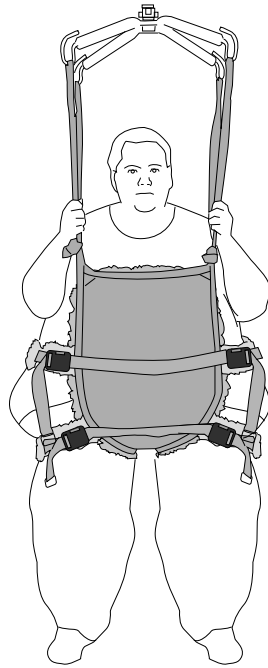

Sling

Instructions for Use



Product Description

Lifting very heavy patients requires special techniques and specially designed lift equipment. Liko has developed the Ultra product series to help lift such patients in a safe and comfortable manner.

The Liko Ultra LiftPants sling, when used in accordance with the information for use, gives very heavy patients the chance to practice standing and gait training without the risk of falling.

The Liko Ultra LiftPants sling aid in safe standing and gait training for patients with poor balance and poor leg function. It is essential that the patient is able to bear weight on their legs. The LiftPants allow the patient to move while relieving him/her of a greater or lesser degree of body weight.

The Liko Ultra LiftPants sling are equipped with two hip straps on either side for more even weight distribution. There are two different sizes.

Selecting a suitable lift

It is recommended that at least two caregivers be present when transferring a patient.

The Liko Ultra LiftPants sling can be used along with Liko's overhead or mobile lifts. An overhead lift can be used by the patient for unrestricted movement within the lift's lifting area. You can choose between:

- Liko's UltraTwin system with two lift units. The maximum load is 500 kg (1100 lbs.), depending on which individual products are included in the assembled lift system. The UltraTwin system is available for both stationary installation and for freestanding installation in the UltraTwin FreeSpan™ system.
- LikoGuard™ L overhead lift for lifting up to 272 kg (600 lbs.) or LikoGuard™ XL overhead lift for lifting up to 363 kg (800 lbs.).
- Viking™ XL mobile lift for lifting up to 300 kg (660 lbs.). May be equipped with arm rest to give extra support during standing- and gait training





















In this document, the person being lifted is referred to as the patient and the person helping them is referred to as the caregiver.

IMPORTANT!

Lifting and transferring a patient always involves a certain level of risk. Read the instructions for use for both the patient lift and lifting accessories before use. It is important to completely understand the contents of the instructions for use. The equipment should only be used by trained personnel. Ensure that the lifting accessories are suitable for the lift used. Exercise care and caution during use. As a caregiver, you are always responsible for the patient's safety. You must be aware of the patient's ability to make it through the lifting situation. If something is unclear, contact the manufacturer or supplier.

Symbol Description

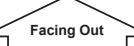
These symbols can be found in this document and/or on the product.

Symbol	Description
	Warning. Used where extra care and attention is needed.
	Read instructions for use before use
	CE mark
	Legal manufacturer
	Date of manufacturing
	Ref number
	Serial Number
	Medical device
	Do not dry clean
	Do not iron
	Tumble drying
	Do not tumble dry
	Washing Symbol is always in combination with recommended temperature in °C and °F.
	Latex Free
	Periodic inspection
	Do not bleach
	Line drying in shade
	Direction upwards and symbol on outside of equipment.
	Symbol on outside of equipment.
 (01) 0100887761997127 (11) YYMMDD (21) 012345678910	GS1 Data Matrix Barcode that may contain following information. (01) Global Trade Item Number (11) Production Date (21) Serial Number

Safety Instructions

Before lifting, keep the following points in mind:

- A responsible person within your organization should decide on a case-by-case basis whether one or more caregivers are needed.
- Ensure that the sling selected meets the patient's needs with reference to model, size, fabric and design.
- The total maximum load for a lift system is always determined by the product in the system with the lowest specified maximum load.
- For safety and hygiene reasons, use individual slings.
- Plan the lifting operation so that it can be done as safely and smoothly as possible.
- Check that the lifting accessory hangs vertically and can move freely.
- Although the Liko sling bars are equipped with latches, special caution must be exercised. Before the patient is lifted from the underlying surface, but when the straps are fully extended, make sure the straps are correctly connected to the sling bar hooks.
- Never lift a patient higher off the underlying surface than is needed to complete the lifting and transfer procedure.
- Never leave a patient unattended during a lifting situation.
- Make sure that the wheels on the wheelchair, bed, gurney, etc., are locked during the lifting/transfer operation.
- Always work ergonomically. Use the patient's ability to actively participate in the operations.
- When the sling is not being used, do not place in direct sun light.

Incorrect attachment of sling to sling bar may cause severe injury to the patient.

 Medical Device Class I Product

PATENT www.hillrom.com/patents

May be covered by one or more patents. See above Internet address.

The Hill-Rom companies are the proprietors of European, US, and other patents and pending patent applications.

Product Changes

Liko's products undergo continuous development, which is why we reserve the right to make product changes without prior notice. Contact your Hill-Rom representative for advice and information about product upgrades.

Design and Quality by Liko in Sweden

Liko is quality certified according to ISO 9001 and its equivalent for the medical device industry ISO 13485. Liko is also certified according to environmental standard ISO 14001.

Notice to Users and/or Patients in EU

Any serious incident that has occurred in relation to the device, should be reported to the manufacturer and the competent authority of the Member State in which the user and/or patient is established.

Care and Maintenance

Check the sling before each use. Check the following points with regard to wear and damage:

- Fabric
- Straps
- Seams
- Loops
- Buckle

⚠ Do not use damaged lifting accessories.

If anything is unclear, please contact the manufacturer or supplier.

If the sling is used for bath or shower: After use in bath and shower situations, the sling should be placed so that it dries as soon as possible.

Washing instructions: Please see the sling's product label and the attached appendix "Care and Maintenance of Liko Slings".

Periodic Inspection

The product must be inspected at least once every 6 months. More frequent inspections might be required if the product is used or washed more often than normal. For protocols please contact your Hill-Rom representative.

Expected Life Time

The product has an expected life time of 1-3 years during normal use. Expected life time varies depending on the fabric, use frequency, washing procedure, and weight carried.

Recycling Instructions

The entire sling, including laths, padding material, etc. should be sorted as Combustible waste.

Hill-Rom evaluates and provides guidance to its users on the safe handling and disposal of its devices to aid in the prevention of injury, including, but not limited to: cuts, punctures of the skin, abrasions, and any required cleaning and disinfection of the medical device after use and prior to its disposal. Customers should adhere to all federal, state, regional, and/or local laws and regulations as it pertains to the safe disposal of medical devices and accessories.

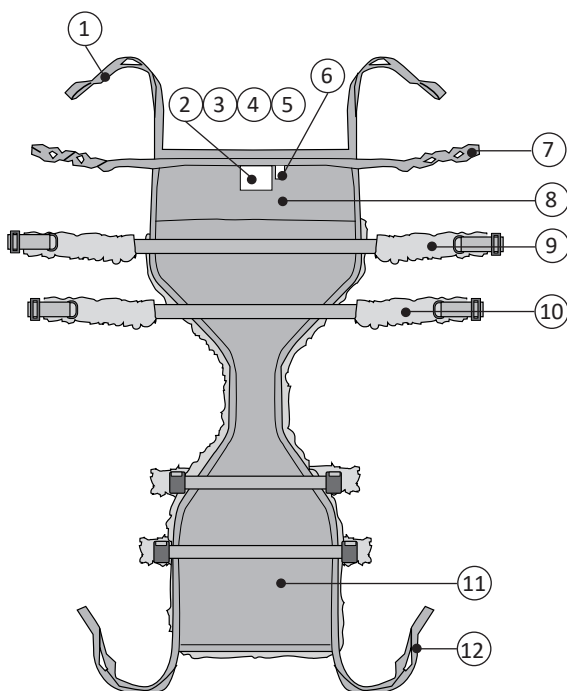

If in doubt, the user of the device shall first contact Hill-Rom Technical Support for guidance on safe disposal protocols

Definitions

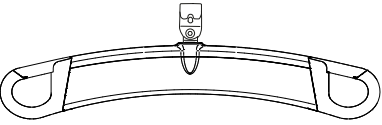
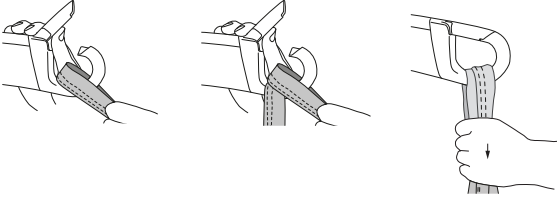
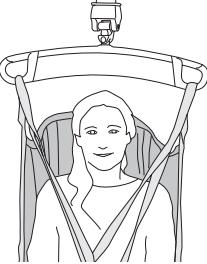
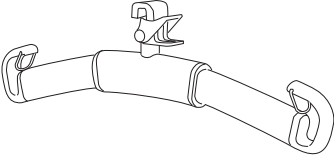
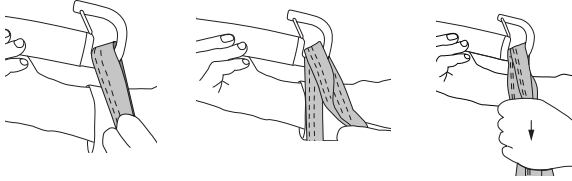

1. Rear suspension straps
2. Product label
3. Serial number
4. Label: Periodic Inspection
5. Label: Individual marking (Belongs to)
6. Size marking (only for size XXL)
7. Loop straps
8. Rear part
9. Upper hip strap
10. Lower hip strap
11. Front part
12. Front suspension strap

How to Attach a Sling to Different Sling Bars

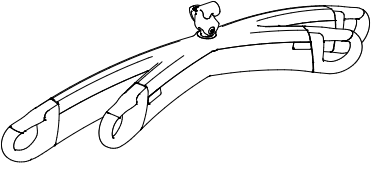
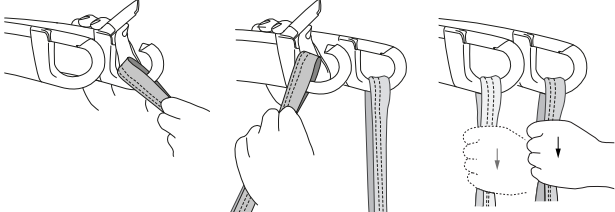
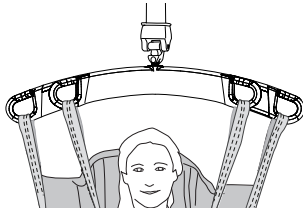
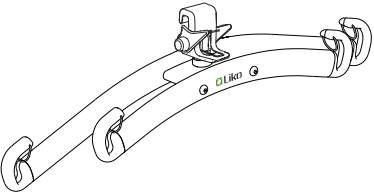
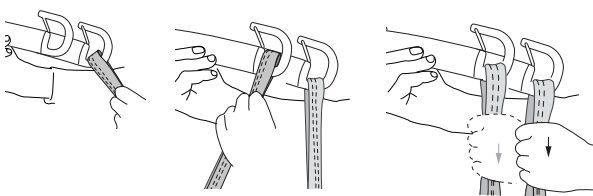
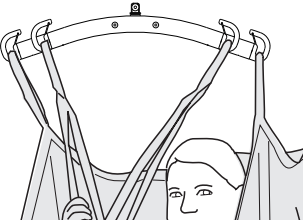
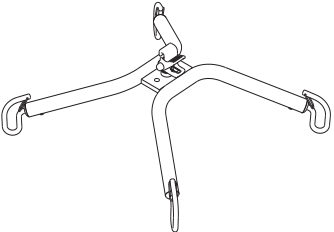
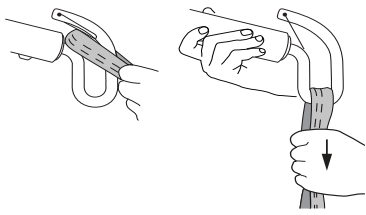
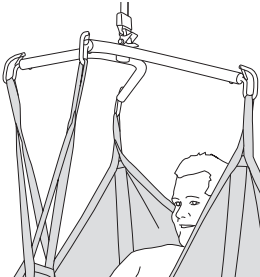
Sling bar	Sling loops to sling bar hooks	Correct
 <p data-bbox="268 495 432 528">SlingGuard™</p>		
 <p data-bbox="288 790 411 824">Universal</p>		
 <p data-bbox="236 1070 469 1104">SlingGuard™ Twin</p>		
 <p data-bbox="252 1368 443 1402">Universal Twin</p>		
 <p data-bbox="288 1671 411 1704">Cross-bar</p>		

Wrong!

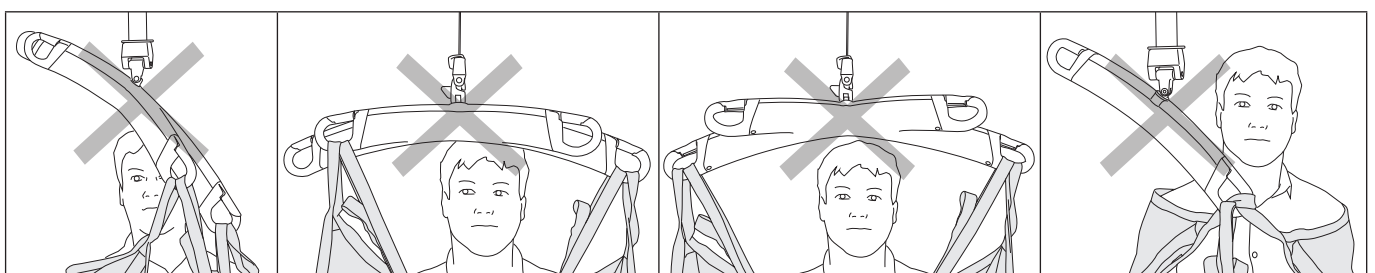

How to Attach an Ultra LiftPants Sling to a Sling Bar with 4 Hooks (Twin Bars and Cross Bars)

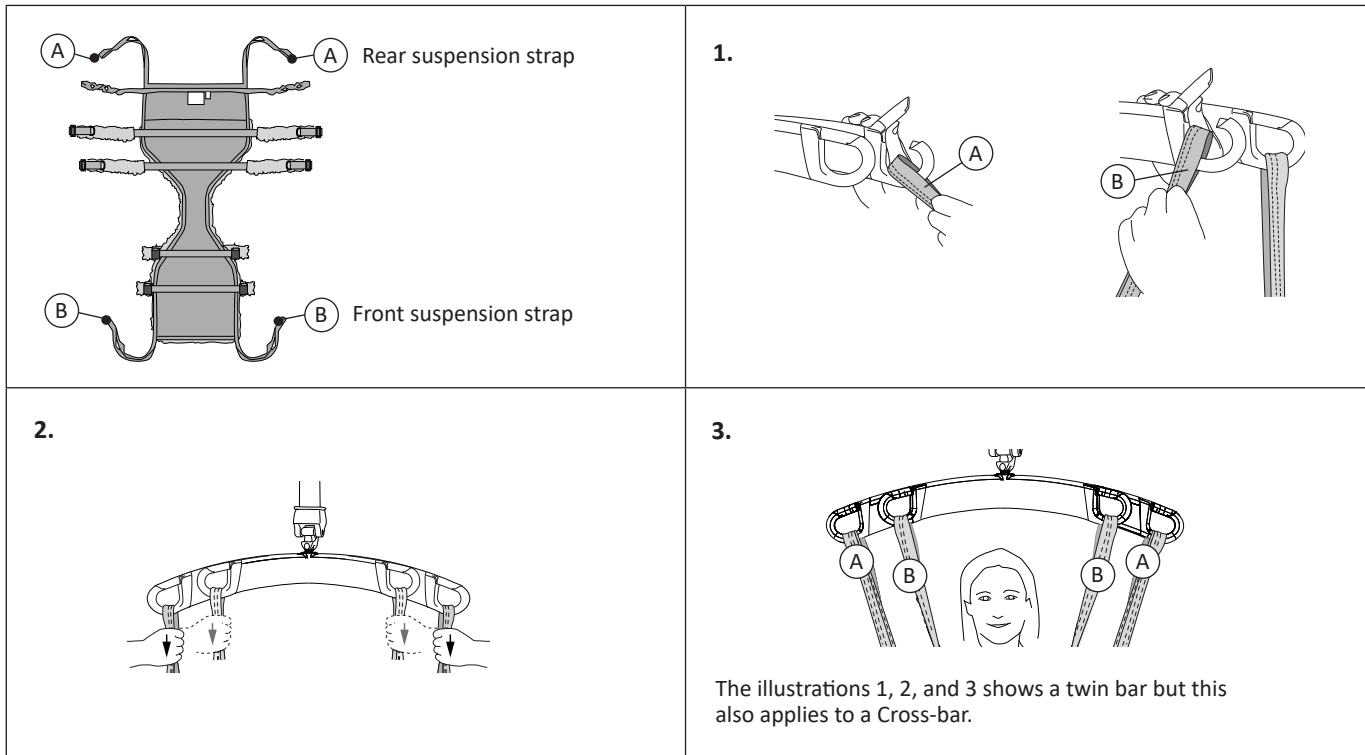

Applying the Ultra LiftPants

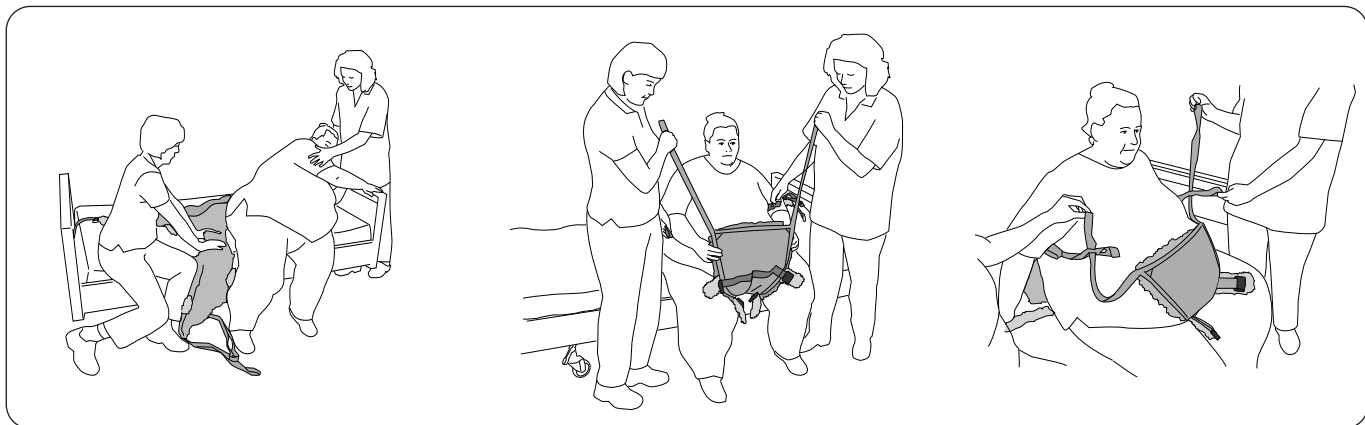

The initial position when using the Liko Ultra LiftPants sling are the sitting position. The patient leans to the side so that the LiftPants sling can be slid into place under the buttocks. Place the LiftPants sling as far under the patient as possible with the product label facing out from the back. Make sure that the LiftPants sling are centered and in a good position with as much pant material in back as in front. Adjust as needed.

Pull the front section of the LiftPants sling up between the legs so that the hip straps are accessible from the front.

Feed the front suspension straps through the loop straps using the appropriate loop (see page 8, Adjusting the Loop Straps).



Alternative application of the Liko Ultra LiftPants sling: The patient can be lifted in a normal sling and then lowered onto the LiftPants sling placed on a chair or at the edge of the bed. The sling used can be e.g. the Liko UltraSling Mod. 06, Liko Original HighBack Sling Mod. 200 or Liko Soft Original HighBack Sling Mod. 26. This application makes it easier if for some reason the patient cannot lean to the side, or if there is no room to apply the LiftPants sling from the side.

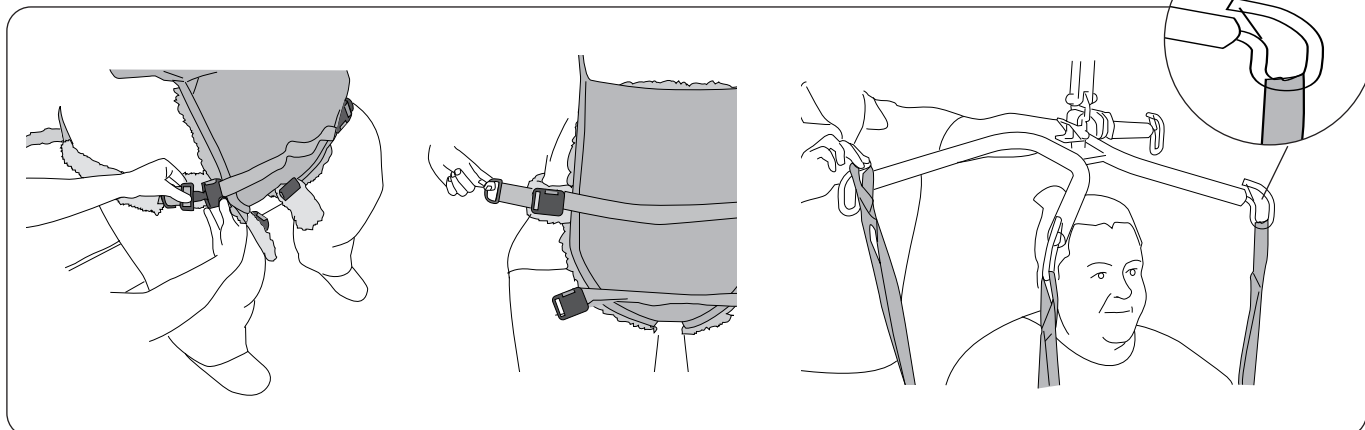

Fasten the hip strap's buckles and pull tight. Depending on the size of the patient, either one or both hip straps may be fastened from the standing position.

Connect the rear suspension straps onto the rear hooks on the sling bar, or onto the rear sling bar. Connect the front suspension straps to the front hooks on the sling bar or to the front sling bar. The outermost strap loop is the most commonly used. See page 5-6 for instructions on how to attach the sling loops to different sling bars.

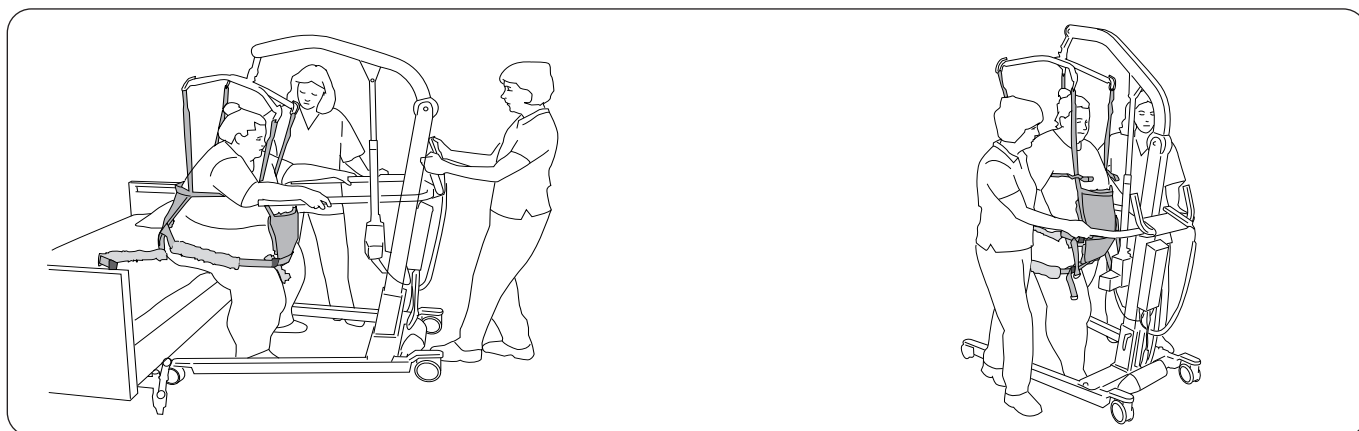

Before assisting the patient to his/her feet: Make sure the patient has a steady footing on the floor to lighten the load during the raising. Run the lift slightly upwards to apply tension to the suspension straps without lifting the buttocks, and make sure that the loop straps are providing adequate support around the patient's upper body.

During the lifting operation: Pull the lift forward in the direction of movement so that weight transfer takes place properly until the patient is upright and well-balanced.

When the patient has gained his/her balance standing, the lifting height is adjusted to provide appropriate relief with help from the LiftPants sling. Gait training can now begin!

Adjusting the Loop Straps

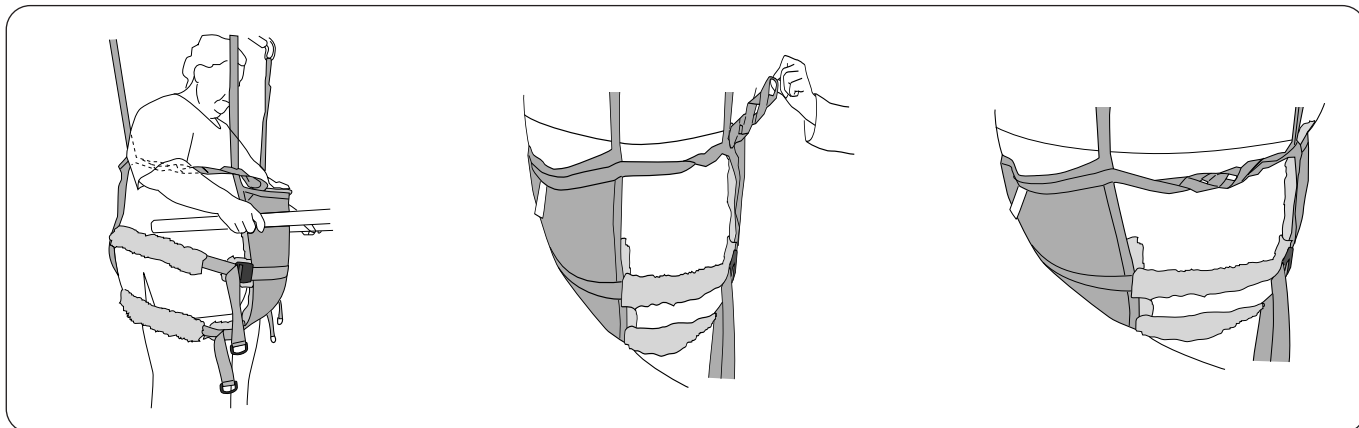

The loop straps should be neither too loose nor too tight around the upper body. Resistance with comfort is best.

A smaller person can have the suspension straps fed through an inner loop.

A larger person can have the suspension straps fed through an outer loop.

Loop Clips

A practical accessory for indicating the loops that work for a certain person. This makes it easier for caregivers to choose the right loop when applying the LiftPants sling.

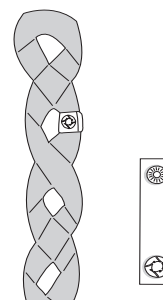

Removing the Ultra LiftPants

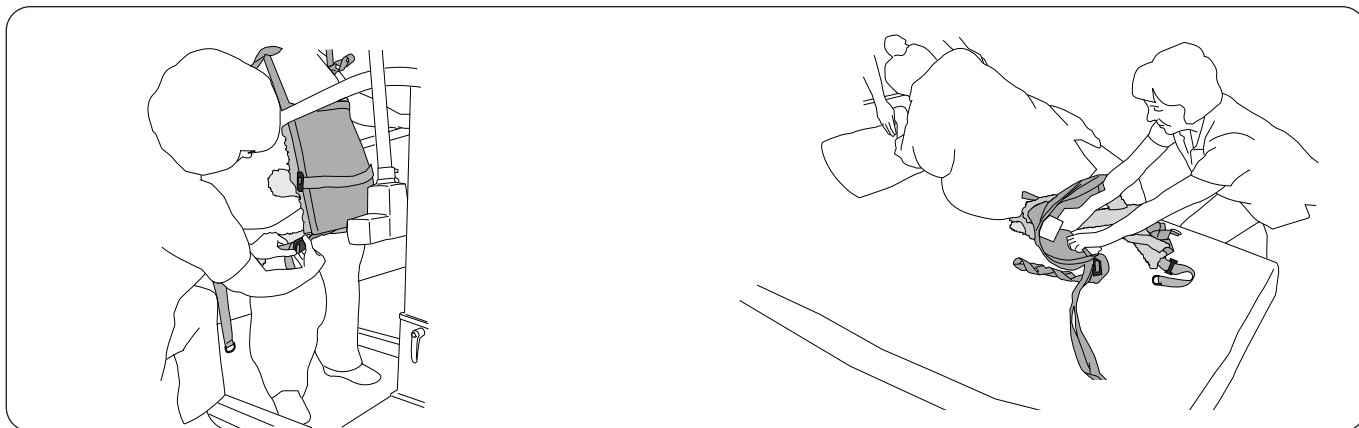

Loosen the hip straps before lowering the patient down into a sitting position to avoid undue pressure from the hip straps.

The patient leans to the side. Seize hold of the outer corner of the rear part of the LiftPants sling. Now fold the LiftPants sling in under itself and pull it away.

Choosing the Right Size

Choosing the right size is important for a safe and secure lift and for reaching the required lift height. Liko Ultra LiftPants sling should reach above waist height but not so high that the loop straps cut into the armpits. Refer to the measurement table below for guidance. Size XXXL has higher fabric sections and longer hip straps in order to reach around a larger belly. **⚠️ Do not choose too large size as this can mean that the required lift height cannot be achieved.**

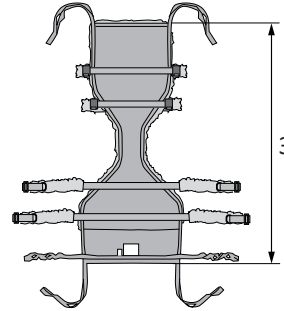
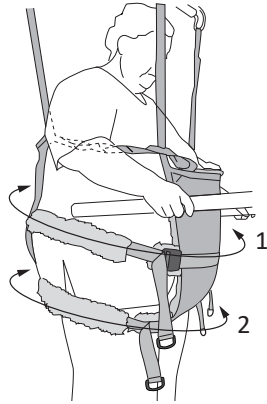

Measurement	1	2	3
XXL	185-260 cm (73-102 inch.)	150-210 cm (59-83 inch.)	140 cm (55 inch.)
XXXL	185-300 cm (73-118 inch.)	150-250 cm (59-98 inch.)	150 cm (59 inch.)

Accessories

Padded cases for shoulder strap

Prod. No. 3666021

Pressure-relieving padded cases for mounting onto the forward and/or rear suspension straps. The padded cases come with Velcro along one longitudinal side for easy mounting.

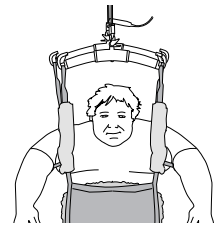

Solo Cover for Ultra LiftPants (XXL/XXXL)

Prod. No. 3692908

Solo Cover for Ultra LiftPants sling (XXL and XXXL) is a protective cover made from disposable material. It is used to avoid dirtying the LiftPants sling and to prevent contagion.

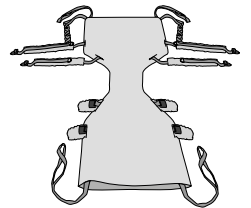
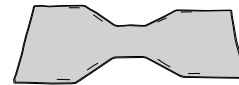

Extension Loop, green, 12 cm (5 in)

Prod. No. 3691102

Extension Loop, green 22 cm (9 in)

Prod. No. 3691103

Extension Loop, grey, 12 cm (5 in)

Prod. No. 3691302

Extension Loop, grey, 22 cm (9 in)

Prod. No. 3691303

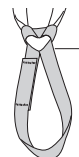

- 2 = 12 cm (5 in)

- 3 = 22 cm (9 in)

Loop Clips, red, 4 pcs

Prod. No. 3666033

Loop Clips, orange, 4 pcs

Prod. No. 3666034

Loop Clips, yellow, 4 pcs

Prod. No. 3666035

Loop Clips, blue, 4 pcs

Prod. No. 3666036

Loop Clips, black, 4 pcs

Prod. No. 3666037

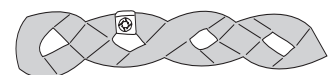

Overview Liko™ Ultra LiftPants™ sling Mod. 920

Product	Prod. No.	Size	Patient weight ¹	Patient height ¹	Maximum load ²	Material
Liko Ultra LiftPants	35920328	XXL	200-500 kg (440-1100 lbs.)	170-210 cm (67-83 inch.)	500 kg (1100 lbs.)	Net polyester
Liko Ultra LiftPants	35920329	XXXL	200-500 kg (440-1100 lbs.)	170-210 cm (67-83 inch.)	500 kg (1100 lbs.)	Net polyester

¹ The indicated patient weight and height are only guidelines – there may be deviations.

² To maintain maximum load, lift/accessories intended for the same load or more are required.

To choose the right size – refer to “Choosing the right size” on page 9.

Recommended Combinations

When using one lift system (LikoGuard™ L and XL overhead lifts, Likorall™ 243 and 250 overhead lifts, Viking™ L and XL mobile lifts)

Recommended combinations of the Liko Ultra LiftPants sling with Liko's sling bars:	Mini 220	Sling bar 350 ³	Sling bar 450 ¹	Sling bar 600 ⁴	Twin bars 670 ²	Ultra Slingbar	Sling Cross-bar 450	Sling Cross-bar 670	Univ. Side bars + Universal 350	Univ. Side bars + Universal 450
Ultra LiftPants, XXL	3	3	2	1	1	4	1	1	4	4
Ultra LiftPants, XXXL	3	3	2	1	1	4	1	1	4	4

¹ Sling bar 450 relates to Universal SlingBar 450 Prod. No. 3156075, 3156085, and 3156095, SlingBar Standard 450 Prod. No. 3156003, and 3156016, and also SlingGuard 450 Prod. No. 3308020 and 3308520.

² Twin bars 670 relates to Universal TwinBar 670 Prod. No. 3156077, and 3156087, and also SlingGuard 670 Twin Prod. No. 3308040 and 3308540.

³ Sling bar 350 relates to Universal SlingBar 350 Prod. No. 3156074, 3156084, and 3156094.

⁴ Sling bar 600 relates to Universal SlingBar 600 Prod. No. 3156076 and 3156086.

Explanation: 1 = Recommended, 2 = May work, 3 = Not advised, 4 = Inappropriate

When using two lift units (UltraTwin™ system), only the below combinations are possible

Recommended combinations of the Liko Ultra LiftPants sling with Liko's sling bars:	Mini 220	Universal 350	Standard 450	Universal 450	Universal 600	Ultra SlingBar
Ultra LiftPants, XXL	3	2	1	1	1	1
Ultra LiftPants, XXXL	3	2	1	1	1	1

Explanation: 1 = Recommended, 2 = May work, 3 = Not advised, 4 = Inappropriate

Other Combinations

Combinations of accessories/products other than those recommended by Liko can result in risks for the safety of the patient.



www.hillrom.com

Liko AB
Nedre vägen 100
975 92 Luleå, Sweden
+46 (0)920 474700

Liko AB is a subsidiary of Hill-Rom Holdings Inc.

Enhancing outcomes for patients and their caregivers:

